

US Banks™

Surfboard Blank Catalog



June 2014

WELCOME

Welcome to the Product Selection Catalog of US Blanks. We are dedicated to offering unmatched value through quality, selection, and service. The products we offer represent the latest in foam technology and design, both classic and contemporary.

Our mission at US Blanks is to establish a close partnership with our customers to produce the best surfboard possible. We have a commitment to stay constantly on the leading edge of current design & technology and to maintain the highest level of quality while offering a wide range of products for custom ordered blanks, including an extensive variety of blank sizes, weights, stringers, rockers and glue colors.

If there is anything we can help you with at any time, please let us know. Our success will only be measured when we have satisfied your needs to the best of our abilities.

OUR COMPANY

The US Blanks team is comprised of former Clark Foam employees and leaders in the surf industry, with over 135 years combined experience in making polyurethane foam surfboard blanks.

We chose to operate in California to provide the best possible service to our customers. Prior to establishing our factory we obtained all the permits required to operate a polyurethane plant in California. We believe we are the only blank manufacturer that is 100% legal to operate in California. Due to the highly profiled nature of using the various chemicals required to manufacture polyurethane foam, it was very important to us that we exercised ALL environmental and safety precautions and requirements to ensure the safety of our employees and neighboring areas, and to solidify the longevity of our company in the marketplace. At US Blanks, we will continue to take all necessary steps to ensure our position at the forefront of environmental and safety standards.

BLANK PICTURES

All blank pictures in this catalog are drawn to the actual scale of the blanks. The wire frame diagrams are derived from the blanks and are drawn on a scale of 1:12 for blank sizes shorter than 8'0", and 1:16 for blank sizes 8'0" and longer. The rocker is taken from the "natural" rocker template and is also to scale. These measurements should enable you to pick the optimum size blank for each board.

The measurements along side the blank picture showing Rocker, Thickness and Width are spaced 6" and 12" apart starting at the nose and tail. The nose and tail rockers are measured from the bottom of the blank to the bottom of the nose and bottom of the tail. You may find the actual measurements of the blanks vary slightly. This is due to the use of mold release, unpredictable shrinkage during molding, rail fill and rough rails. All of these factors can cause slight measurement variations from blank to blank.

Volume measurements are also listed for each blank size. These measurements are calculated using the Shape 3D scan method created from each model. Shape 3D and AKU computer files for each blank size are also available upon request. Please call our office for more details.

FOAM SELECTION

US Blanks manufactures a water blown, Toluene Diisocyanate based polyester polyurethane blank. We feel this combination provides the best physical properties required by a surfboard, resulting in the strongest blank possible, and yields the best performance qualities. The quality, stability and consistency of a TDI based polyurethane blank has long made it the choice of the majority of board builders.

While there are many formulations available for a TDI based blank, we believe our formulation provides the optimum strength while maintaining ease of shaping and maximum flex. We are continuously fine tuning our formulation to supply the shaper with a blank that exceeds industry standards for these characteristics.

US Blanks has also spent considerable time and resources exploring alternate technologies in surfboard manufacturing. The rapidly progressing developments of epoxies have brought forth a very viable alternative for many board builders. As a result of our extensive research and development we now offer our alternative product line of "Superfused Molded EPS Foam Blanks." These blanks are currently produced in 6 different sizes, 2 different densities (1.7 pcf and 2.0 pcf) as well as several different thicknesses giving unlimited options to the shaper. Recognizing the importance of this technology we wanted to ensure that our customers are provided with the very best EPS foam on the market. Our SUPERFUSED EPS product line has set a new industry standard and we look forward to advancing and developing this technology even further into the future. Our EPS molded blanks can be found immediately following the Polyurethane Blank Section in this catalog.

We also offer EPS blanks cut from high quality block foam in two densities, offering an unlimited selection of sizes. Our block / billet material is the highest quality "surf specific" material on the market and is only available through US Blanks. Our stock sizes are listed toward the back of this catalog, In addition, custom cut files may be submitted in either Shape 3D or AKU Shaper formats. Available stock densities are 1.5 pcf and 2.0 pcf. with minimum quantity. 1.0 pcf can also be custom ordered.

DENSITY COMPARISON

To provide a truly custom polyurethane blank, we offer several densities from which to choose. At this time we offer most blank sizes in every weight, however not all weights will be stocked in all sizes. Sales will dictate what sizes are stocked in what density.

Actual pounds per cubic foot of a given weight foam will vary with blank size due to mold compaction and skin to core ratio. The comparisons listed are based on the difference in pounds of foam used to pour each density and is an average among blank sizes.

The density of a blank will be identified by the color of the paint on the nose.

Densities are listed from lightest to heaviest:

ORANGE, approximately 12% - 13% lighter than BLUE. Currently only available in short boards.

RED, approximately 6% - 7% lighter than BLUE.

BLUE is considered our stock density and is the basis for comparison.

GREEN, approximately 9% - 10% heavier than BLUE

CLASSIC, approximately 30% - 32% heavier than BLUE. These blanks will be identified with a brown tipped nose.

TOW-IN, approximately 205% heavier than BLUE. These blanks will be identified with a black tipped nose.

BLANK SIZE AVAILABILITY

Our processing cycle limits the number of molds that can be in production at any given time. Any blank size that is not in production relies on factory stocking to fill orders. There are a number of sizes which remain in constant production; all others will rotate in and out of production based on inventory and order levels.

When a mold is removed from production we try to stock for anticipated orders up to the time it should rotate back into production. Almost all blank sizes are inventoried in RED and BLUE densities, with most of the short boards also inventoried in ORANGE and the longer boards also inventoried in GREEN. A limited quantity of CLASSIC will be stocked for a select few long board sizes. TOW-IN density is by custom order only. Our entire blank inventory is stocked unglued therefore all blanks are “glued to order”.

COLORED FOAM

US Blanks offers colored foam for stringers and full colored foam blanks.

Our colored stringer foam is made in Classic density and is available in stock colors of Blue, Red, Yellow, Green, Black, Pink and Gray. We formulate our colors to be bright and bold. Occasionally we may have additional colors available.

Colored blanks are available for all sizes and all densities on a custom order basis. We offer colored blanks in the same colors as our stringer foam, and can also formulate any shade of the stock colors. Custom colors are available for minimum quantity orders. Let your imagination run wild as we can create unlimited colored blank combinations. Mix and match colors in any given blank - even with your parabolic rails!

It may be possible to develop a proprietary custom color. Please contact our office for information.

STRINGER SELECTION

US Blanks currently offers five wood types for stringer selection: basswood, red cedar, balsa, colored 3 ply bass plywood, and three different combinations of 4mm unidirectional plywood.

Our in-house mill capabilities allow us to offer any thickness of bass or cedar wood stringer, including wedges. Some limits are set by the length or width of wood available. Our red cedar comes 6" wide and will not fit all rockers, and our plywood has a length limit of 8'1".

Multiple stringer T-bands, off-set stringers, and Models A's are all part of our custom stringer capability, along with any conceivable straight cut.

Parabolic rail stringer configurations are also available in a variety of different blank sizes. Our standard parabolic templates can be used in any of our shortboard sizes to suit your finished board dimensions and requirements. For a list of our template outlines and configurations please refer to the parabolic specification pages at the end of this catalog.

ROCKER SELECTION

Everyone knows how important rocker is to the performance of a surfboard. US Blanks offers custom rockers **at no charge**, including private rocker templates.

While our master plugs were designed with a Natural Rocker that fits a variety of designs, we know that individual style and design will require adjustments.

At US Blanks we use the deck line to adjust rocker, and all adjustments are referenced to the Natural Rocker. If desired we can adjust rocker to the bottom. Adjustments can be made from almost any point on a blank and from one blank size to another. Unless instructed, all rocker adjustments will be made from the center of the blank. If the adjustment is made from a point other than center, the adjustment point will be part of the description. Rockers transferred from one blank size to another will require a match point. Radical rocker adjustments may result in bumps or dips created in the deck line.

Private rocker templates will be named and used only upon permission of the owner.

Rocker adjustments on block cut EPS blanks may be charged a slight fee, based on complexity of file adjustment required.

QUALITY GUARANTEE

US Blanks will stand behind the quality of our blanks. If you receive a blank that has been determined to be an inferior product, based on US Blanks quality standards, we will replace the blank. In addition, if that blank has been shaped we will credit the customer with an additional blank **OR** a scheduled shaping fee. In order to be eligible for either credit, the inferior blank must be returned to US Blanks. We will not cover the costs of any work on the blank completed after the first notice of a problem. Refer to the US Blanks Sales Policy for specific details.



Call (310) 225-6774 or visit www.usblanks.com

BLANK CODE DESCRIPTION

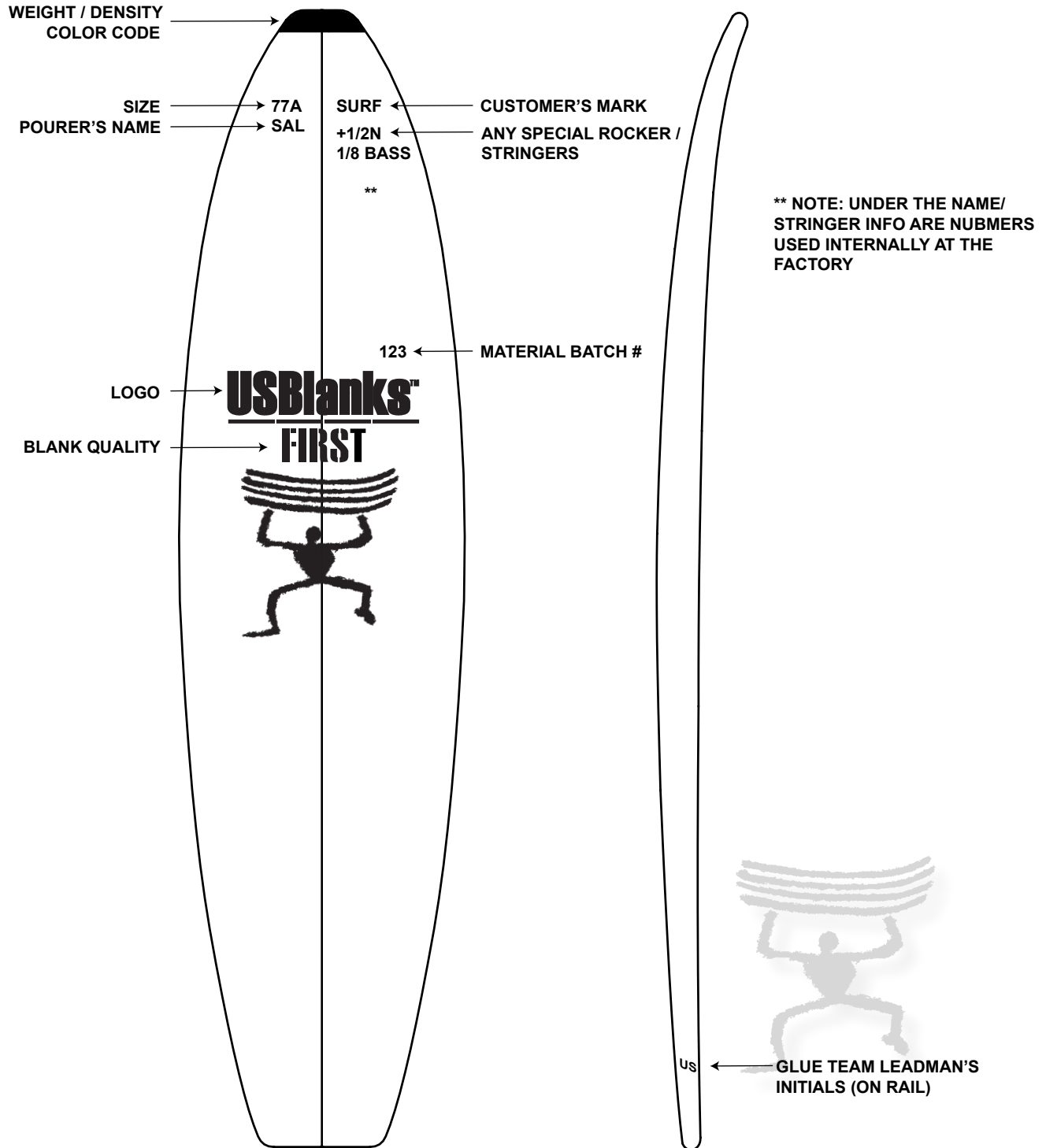



Call (310) 225-6774 or visit www.usblanks.com

5'9" P

Overall Bottom Length: 5'10 1/4" (178.44 cm)

Tip-to-tip Deck Length: 5'9 5/8" (176.85 cm)

Maximum Width: 19 3/8" (49.21 cm)

Maximum Thickness: 2 7/16" (6.19 cm)

Displacement: 1.14 ft³ (32.2 L)

Introduced: April 2006

Available Rockers: Refer to **Rocker Catalog**

Shaper's Comments: This is an ideal "Grom" blank with medium volume. It has an excellent natural rocker which will also work very well in the 6'0P and 6'2P matched from the nose. A perfect hand shape blank that can also be used on the machine.

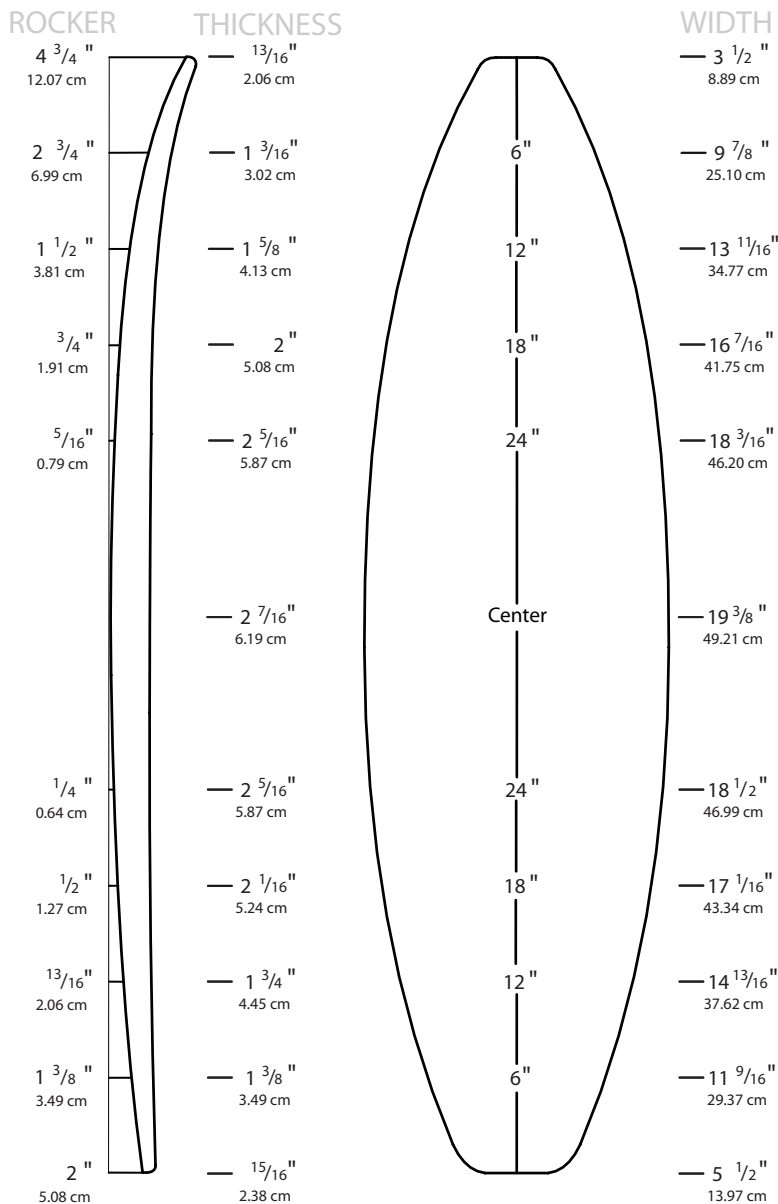

Designed and shaped by: **Timmy Patterson**



Call (310) 225-6774 or visit www.usblanks.com

5'10" RP

Overall Bottom Length: 5'11 1/4" (180.98 cm)

Tip-to-tip Deck Length: 5'10 3/4" (179.71 cm)

Maximum Width: 24 7/8" (63.18 cm)

Maximum Thickness: 2 15/16" (7.46 cm)

Displacement: 1.91 ft³ (54.1 L)

Introduced: October 2008. Designed for the ongoing fish revolution. This follow through design flows from the universally accepted 6'2" C from 1994.

Rockers: Natural

Classic Frye (-1"N24")

Small Frye (-1/2"N24")

Island Lis (+7/16"N9" +1/8"T)

Shaper's Comments: Versatile. Designed for the modern hand shaper drawing on input from each of the "Fish Fry" events attended (American, Australian, European, as well as Japan). Modified and updated for machine use. Will easily net 5'10" deck measurement with high performance rockers and thickness profiles. With much time abroad put in at the line ups of Africa, South America, elsewhere and beyond the the 5'10" RP integrates input from many of surf designs most traveled exponents minds. We enjoy this blank in the "Greenroom Guild" setting with 4" of center removed for our vision of the high performance fish. Inspired by the futuristic surfing of Daniel "TOMO" Thomson.

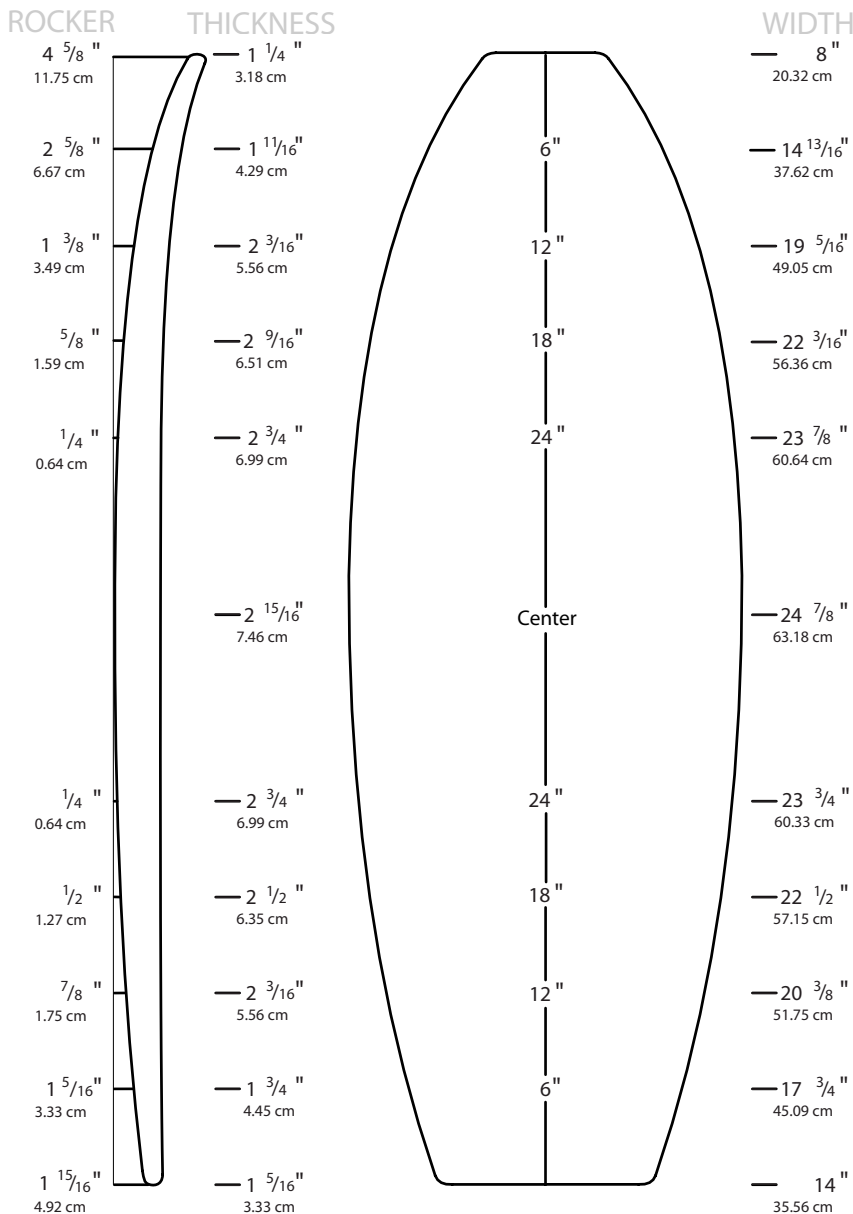

Designed and shaped by: **Rich Pavel**



Call (310) 225-6774 or visit www.usblanks.com

6'0" P

Overall Bottom Length: 6'0 3/4" (184.15 cm)

Tip-to-tip Deck Length: 6'0 1/4" (182.88 cm)

Maximum Width: 20" (50.80 cm)

Maximum Thickness: 2 1/2" (6.35 cm)

Displacement: 1.23 ft³ (34.9 L)

Introduced: January 2007

Available Rockers: Refer to **Rocker Catalog**

Shaper's Comments: This is a close to medium tolerance blank excellent for Junior sizes. Adjusted thickness flow in the nose and tail makes this a perfect quick shape blank. The design was based off the 6'2P.

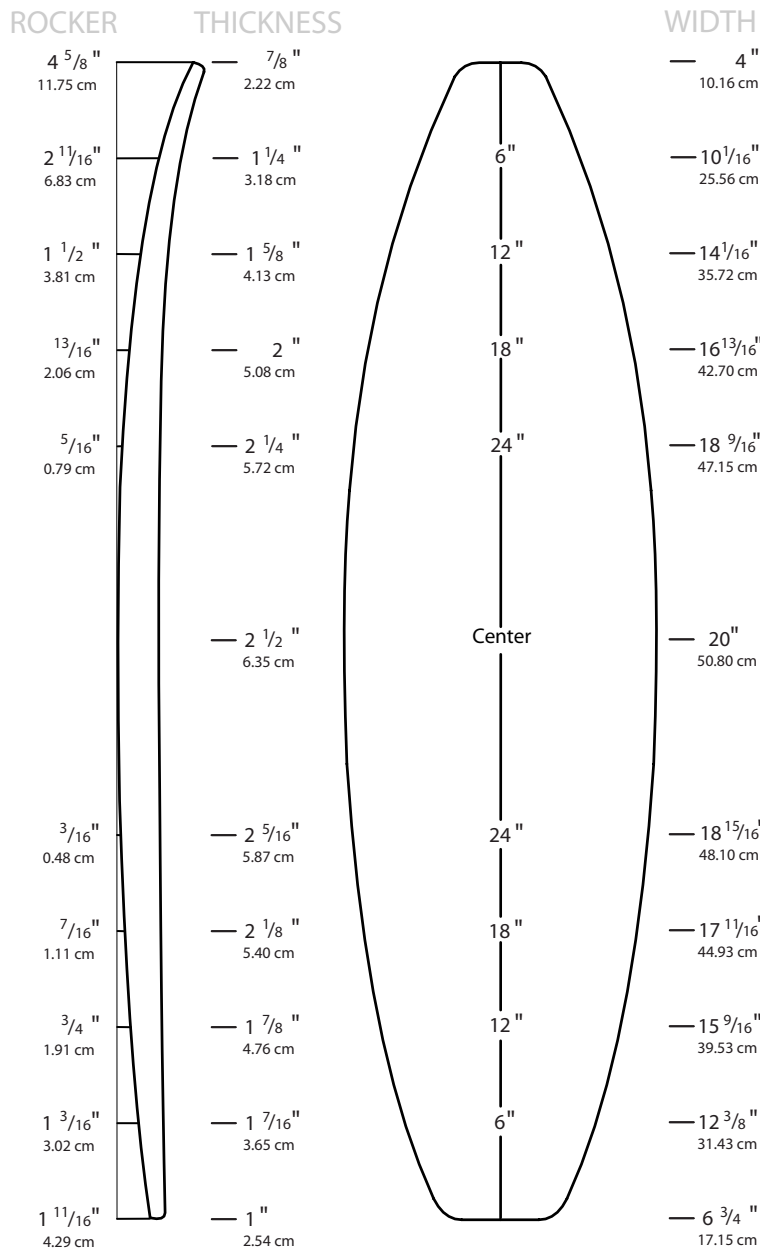

Designed and shaped by: **Timmy Patterson**

Call (310) 225-6774 or visit www.usblanks.com

6'0"R

Overall Bottom Length: 6' 0 1/2" (184.15 cm)

Tip-to-tip Deck Length: 5' 11 3/4" (182.25 cm)

Maximum Width: 21 5/8" (54.93 cm)

Maximum Thickness: 3" (7.62 cm)

Displacement: 1.667 ft³ (47.2 L)

Introduced: March 2011

Available Rockers: Refer to **Rocker Catalog**

Shaper's Comments:

Designed to be a versatile blank for shorter, wider, relaxed rockered boards. Somewhere between a fish and performance short board. Semi-flat deck, and thicker on the ends should provide a wide range of options.

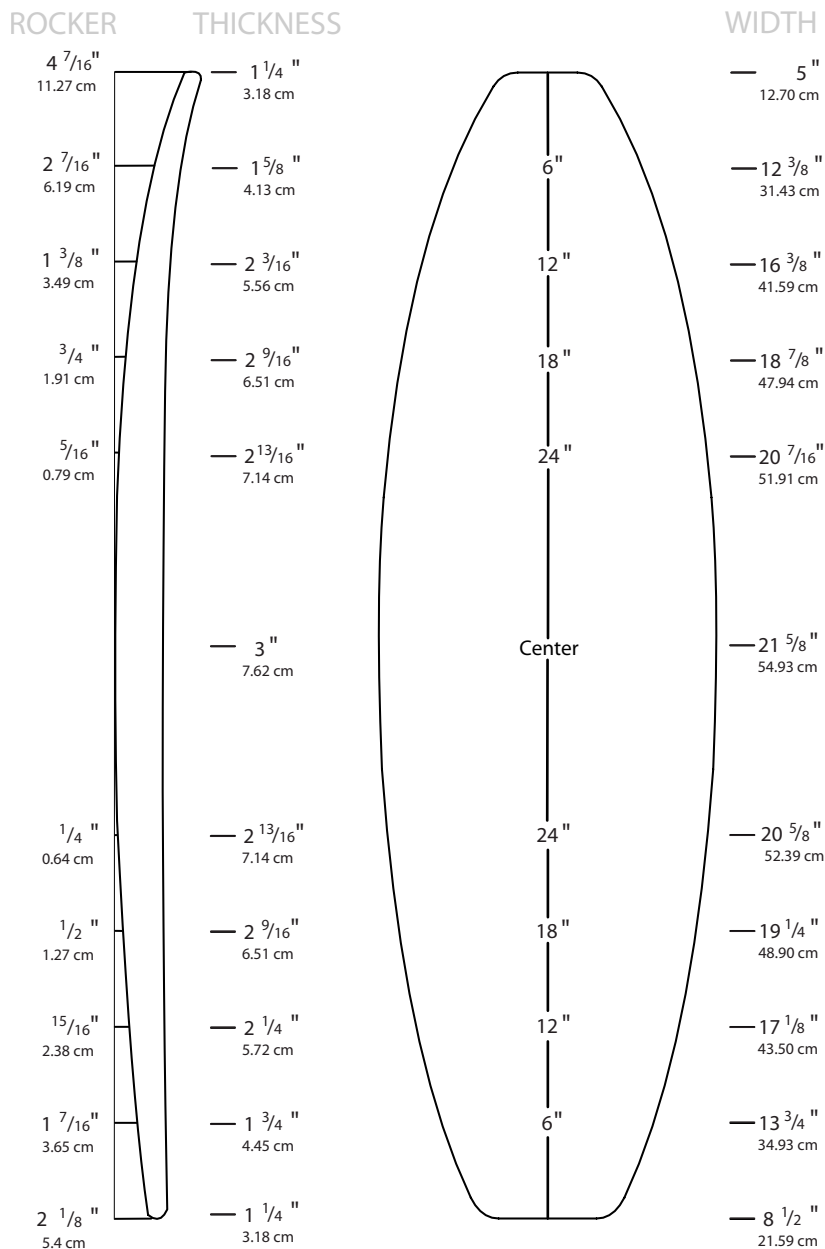

Call (310) 225-6774 or visit www.usblanks.com

6'2" A

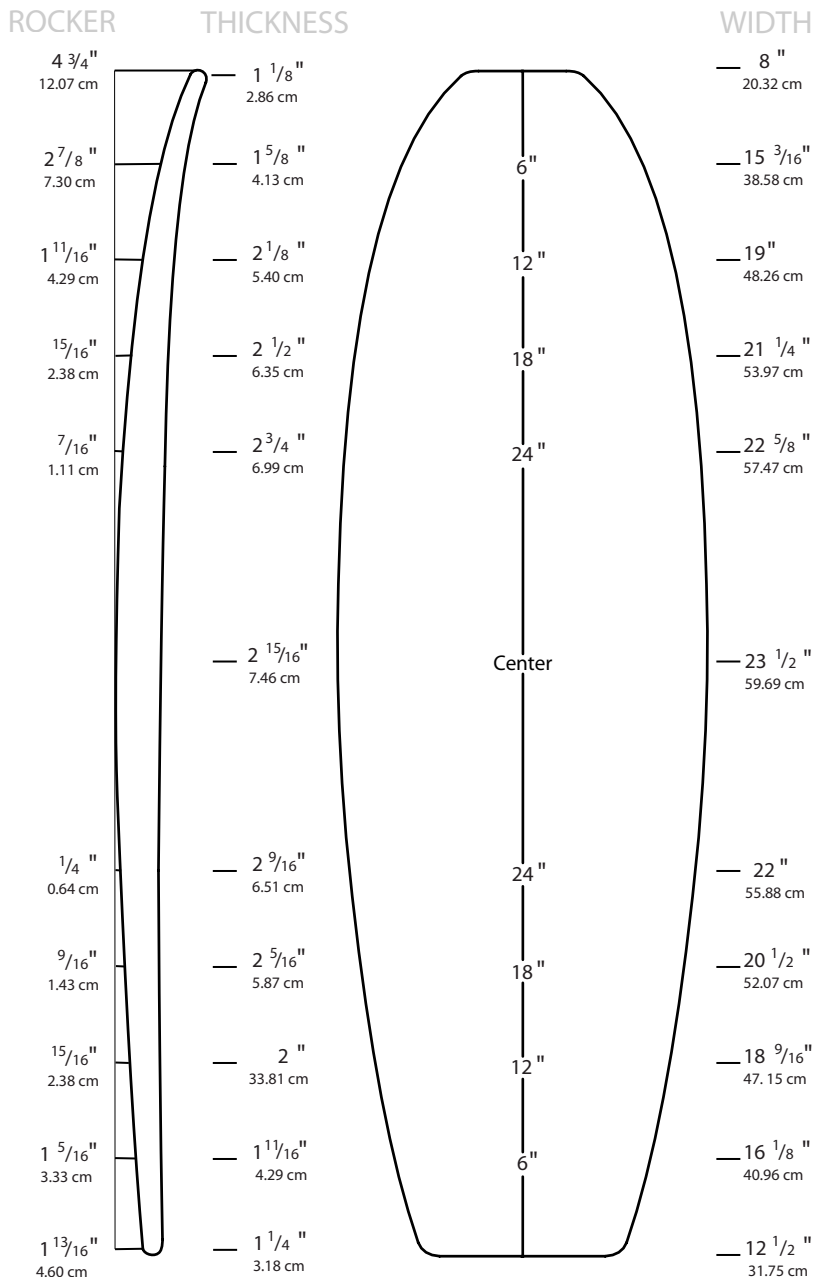

Overall Bottom Length: 6' 2 3/4" (189.87 cm)

Tip-to-tip Deck Length: 6' 2" (187.96 cm)

Maximum Width: 23 1/2" (59.69 cm)

Maximum Thickness: 2 15/16" (7.46 cm)

Displacement: 1.95 ft³ (55.1 L)

Introduced: July 2006

Available Rockers: Refer to **Rocker Catalog**

Shaper's Comments: This is my version of the previous 6'2"C fish blank. I designed this one as to be able to easily net a 6'2" by the bottom measurement. Bottom rocker is a shorter version of the natural rocker of the 6'9"A I made in 2002. This blank can be ordered wider or narrower as to allow for stronger decks/rails near the perimeter of the board outline, and less waste.





Call (310) 225-6774 or visit www.usblanks.com

6'2"P

Overall Bottom Length: 6' 2 1/2" (189.23 cm)

Tip-to-tip Deck Length: 6' 1 7/8" (187.64 cm)

Maximum Width: 20 1/2" (52.07 cm)

Maximum Thickness: 2 1/2" (6.35 cm)

Displacement: 1.31 ft³ (37.2 L)

Introduced: July 2006

Available Rockers: Refer to **Rocker Catalog**

Shaper's Comments: Blank is designed for team boards and production shaping. It is a shorter version of the 6'7"P, which has a little more thickness in the nose and tail than the original. A medium tolerance blank.

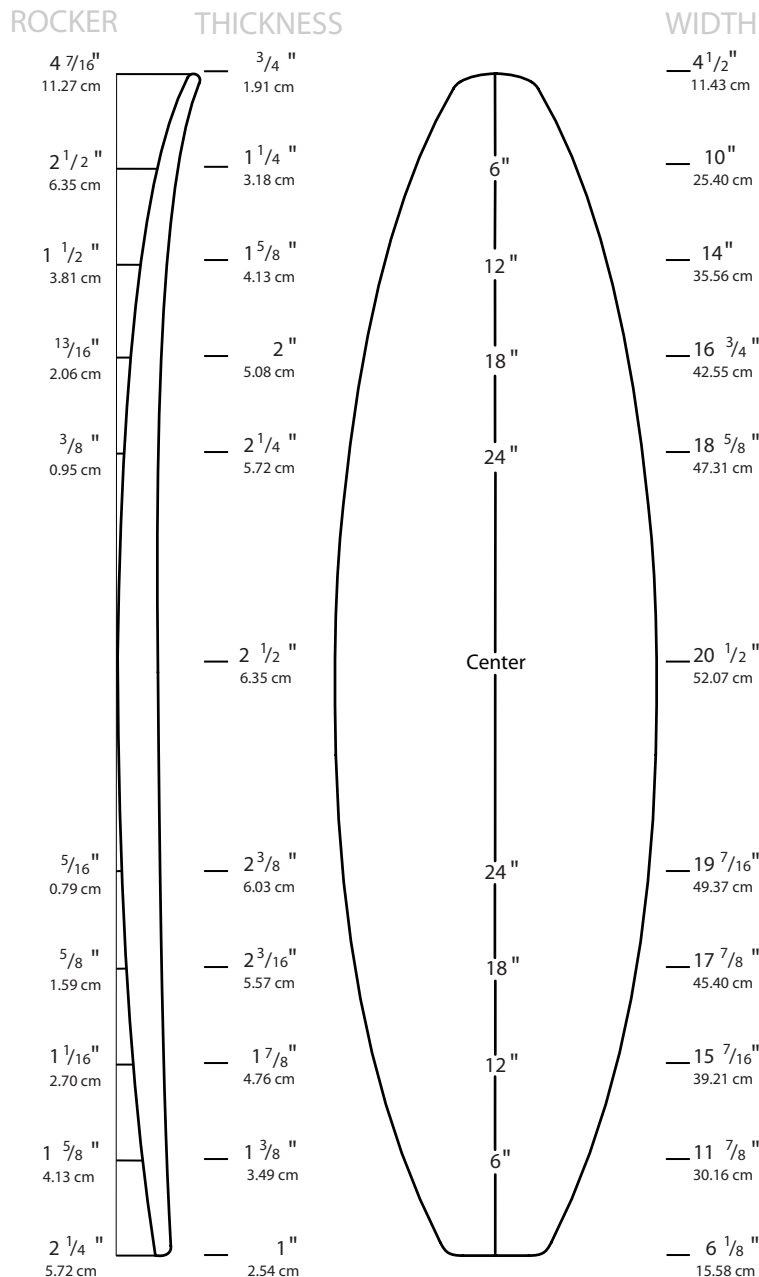

Designed and shaped by: **Timmy Patterson**



Call (310) 225-6774 or visit www.usblanks.com

6'3" EA

Overall Bottom Length: 6' 4 1/8" (193.36 cm)

Tip-to-tip Deck Length: 6' 3 1/4" (191.14 cm)

Maximum Width: 20 5/8" (52.39 cm)

Maximum Thickness: 2 9/16" (6.51 cm)

Displacement: 1.38 ft³ (39.2 L)

Introduced: July 2006

Available Rockers: Refer to [Rocker Catalog](#)

Shaper's Comments: This is a thinner version of the 6'4" EA.

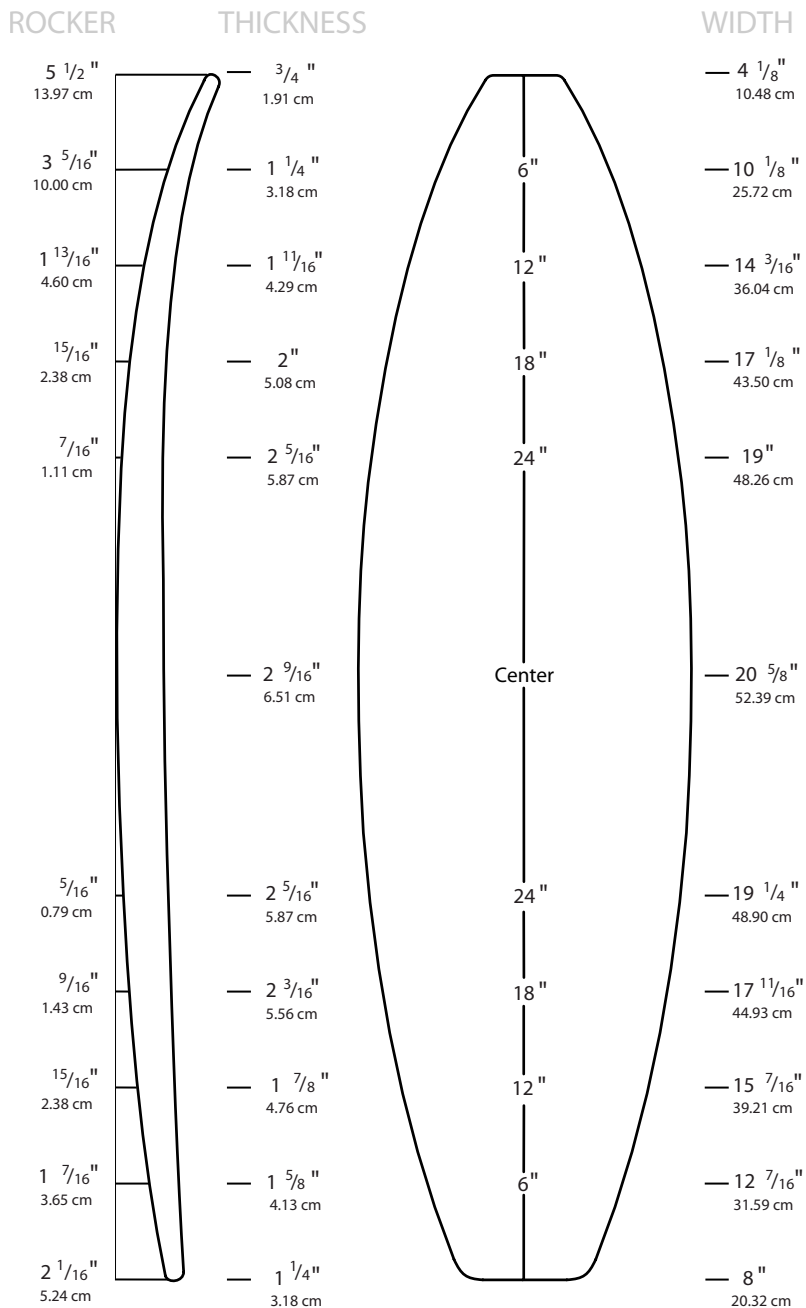

Designed and shaped by: **Eric Arakawa**



Call (310) 225-6774 or visit www.usblanks.com

6'4"EA

Overall Bottom Length: 6' 4 1/4" (193.66 cm)

Tip-to-tip Deck Length: 6' 3 1/2" (191.14 cm)

Maximum Width: 20 5/8" (52.39 cm)

Maximum Thickness: 2 3/4" (6.99 cm)

Displacement: 1.49 ft³ (42.3 L)

Introduced: July 2006

Available Rockers: Refer to [Rocker Catalog](#)

Shaper's Comments: Designed to be a versatile blank for boards 6'2" and under. I added a little nose width to accommodate most modern full nose short boards.

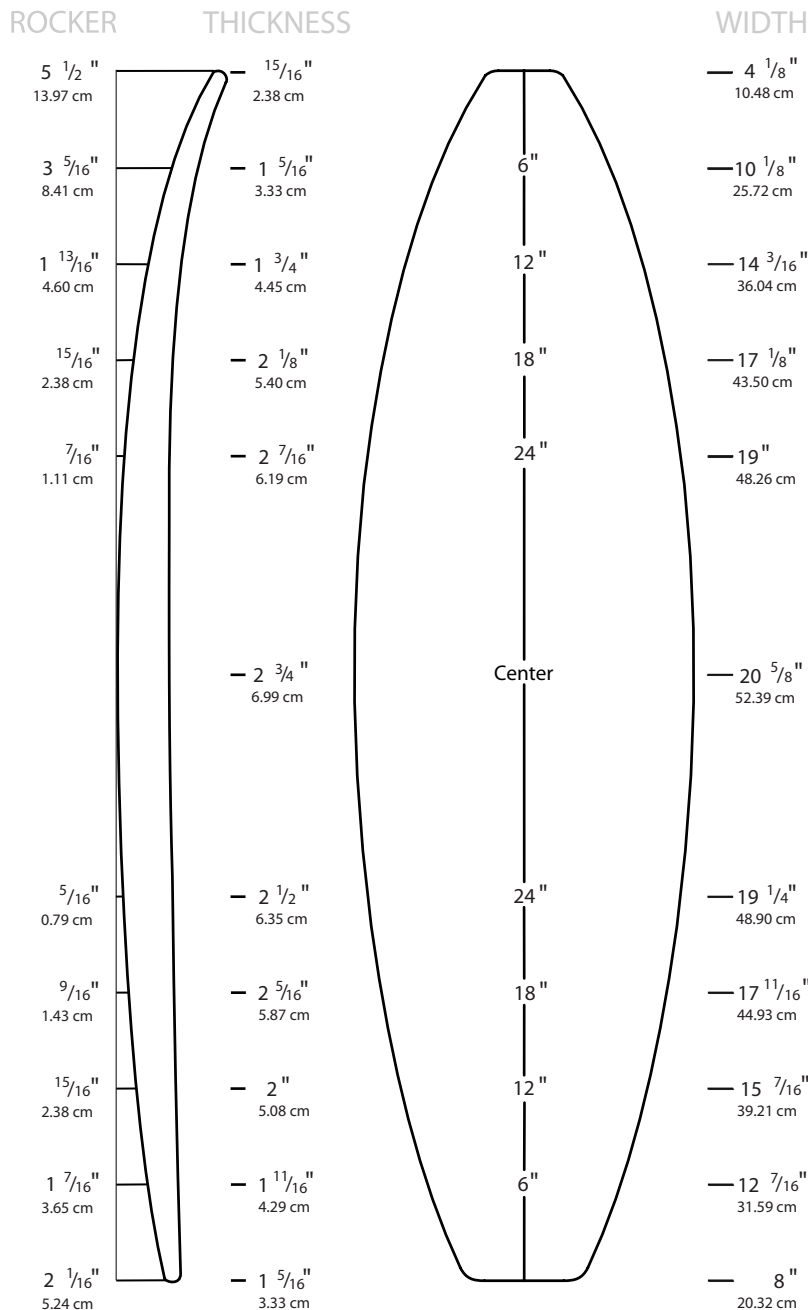

Designed and shaped by: **Eric Arakawa**

Call (310) 225-6774 or visit www.usblanks.com

6'5" A

Overall Bottom Length: 6' 5 1/2" (196.85 cm)

Tip-to-tip Deck Length: 6' 4 7/8" (195.26 cm)

Maximum Width: 23 1/2" (59.69 cm)

Maximum Thickness: 3 1/8" (7.94 cm)

Displacement: 2.15 ft³ (60.9 L)

Introduced: July 2006

Available Rockers: Refer to [Rocker Catalog](#)

Shaper's Comments: This is my longer version of the previous 6'2"C fish blank. I designed this one as to be able to easily net a 6'5" by the bottom measurement. Bottom rocker is a shorter version of the natural rocker of the 6'9"A I made in 2002. I basically "shrunk down" the 6'9"A for this mold design. This blank can be ordered wider or narrower as to allow for stronger decks/rails near the perimeter of the board outline, and less waste.

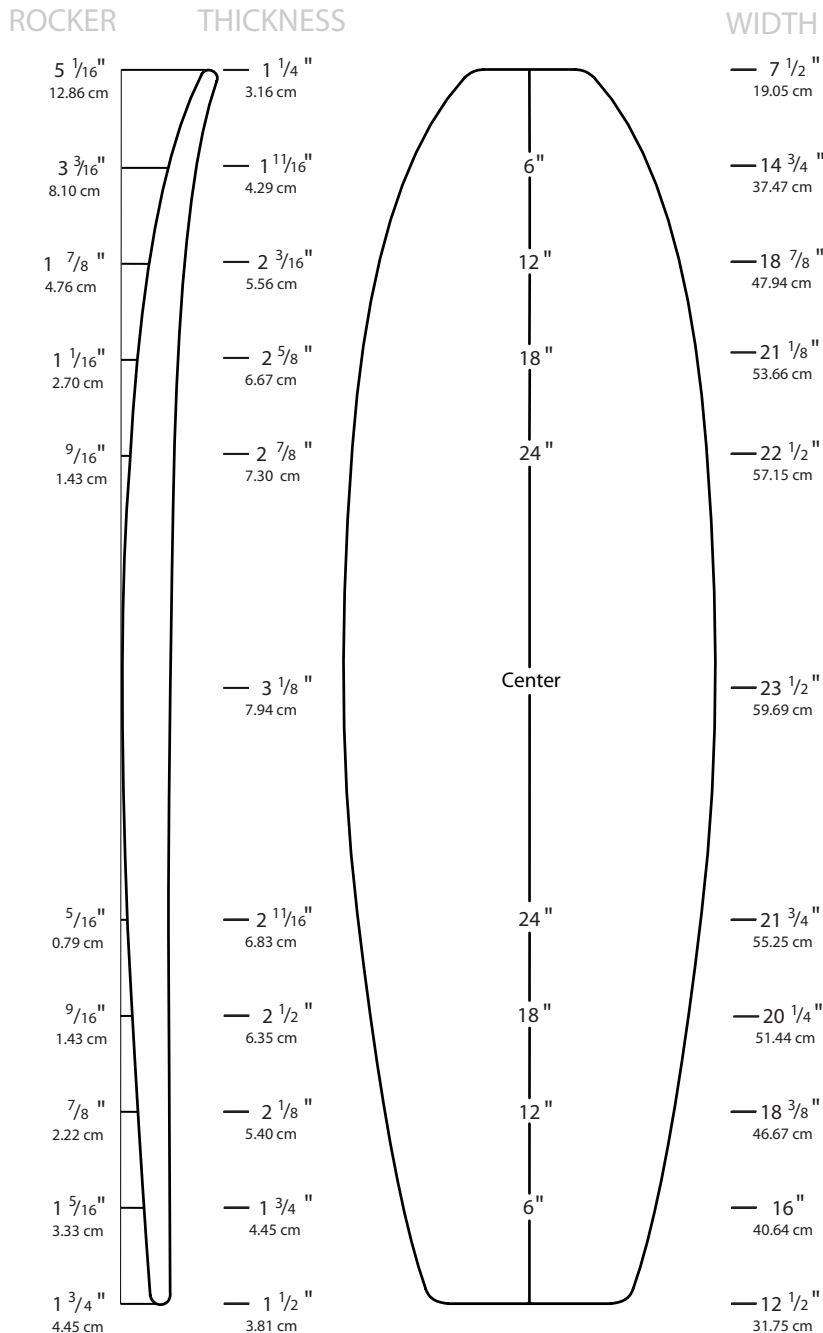

Designed and shaped by: **Pat Rawson**

Call (310) 225-6774 or visit www.usblanks.com

6'5"R

NEW "R" SERIES AVAILABLE NOW!

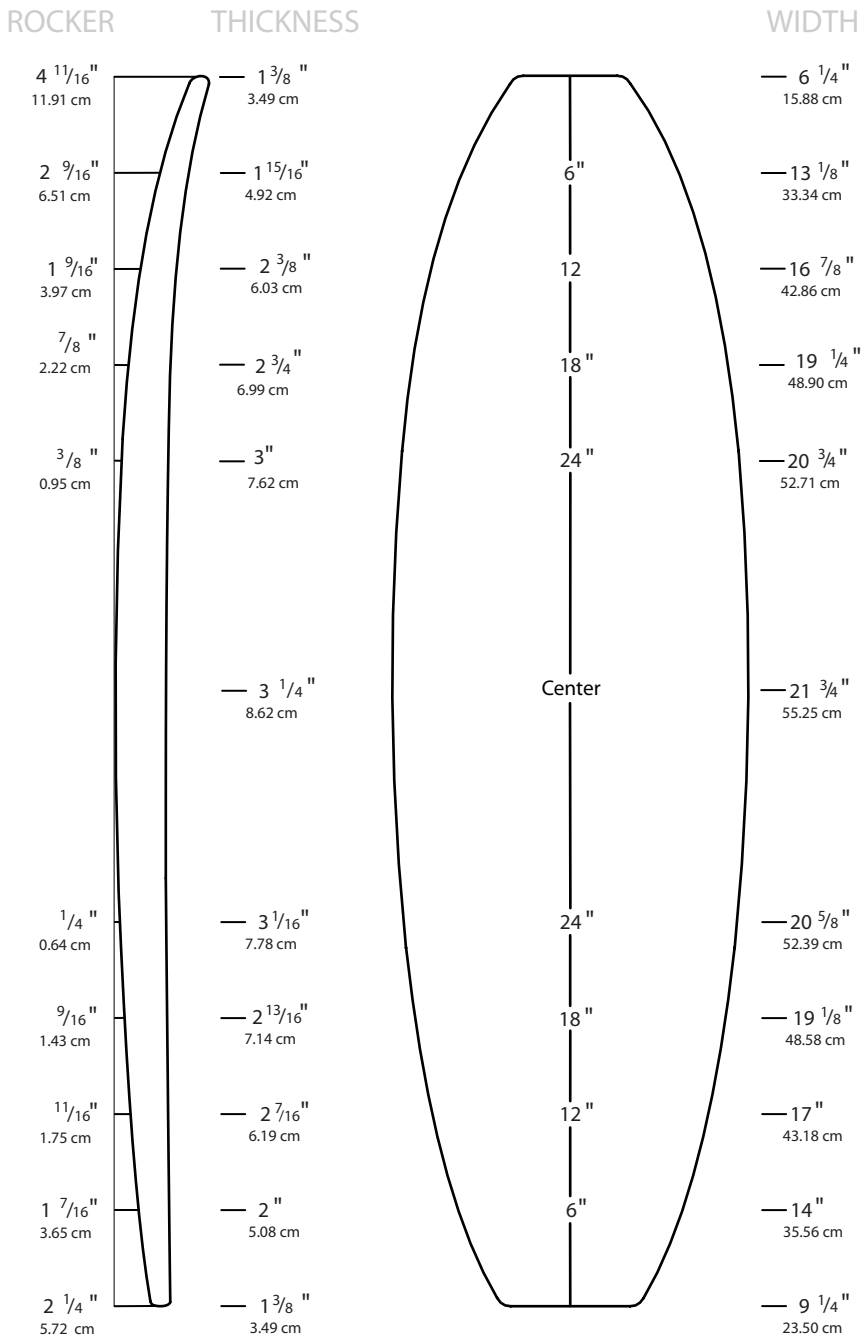

Overall Bottom Length: 6' 5 1/2" (196.85 cm)

Tip-to-tip Deck Length: 6' 4 3/4" (194.95 cm)

Maximum Width: 21 3/4" (55.25 cm)

Maximum Thickness: 3 1/4" (8.26 cm)

Displacement: 1.98 ft³ (56.0 L)

Introduced: April 2011

Available Rockers: Refer to **Rocker Catalog**

Shaper's Comments:

This is the larger version of the 6'0R.

Designed to be a versatile blank for shorter, wider, relaxed rockered boards. Somewhere between a fish and a performance short board. Semi-flat deck, and thicker on the ends should provide a wide range of options.





Call (310) 225-6774 or visit www.usblanks.com

6'6" EA

Overall Bottom Length: 6' 6 1/8" (198.44 cm)

Tip-to-tip Deck Length: 6' 5 3/8" (196.22 cm)

Maximum Width: 21 1/4" (53.98 cm)

Maximum Thickness: 2 15/16" (7.46 cm)

Displacement: 1.65 ft³ (46.7 L)

Introduced: July 2006

Available Rockers: Refer to **Rocker Catalog**

Shaper's Comments: This fills the gap between the 6'3" EA and the 6'9" EA.

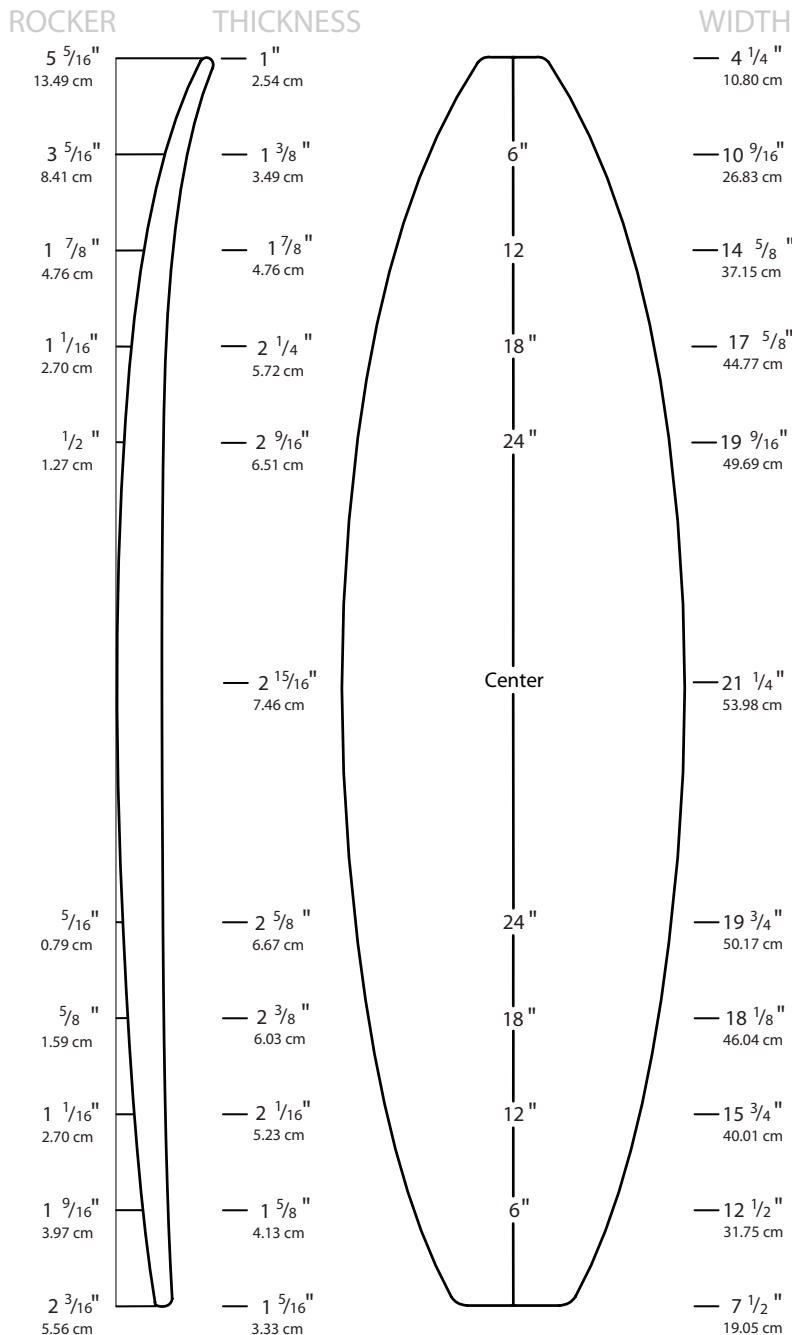

Designed and shaped by: **Eric Arakawa**



Call (310) 225-6774 or visit www.usblanks.com

6'7" P

Overall Bottom Length: 6' 7 1/8" (200.66 cm)

Tip-to-tip Deck Length: 6' 6 1/2" (198.76cm)

Maximum Width: 21 1/2" (54.61 cm)

Maximum Thickness: 2 3/4" (6.99 cm)

Displacement: 1.54 ft³ (43.6 L)

Introduced: July 2006

Available Rockers: Refer to **Rocker Catalog**

Shaper's Comments: Blank is designed for team boards and production shaping. It has a little more thickness in the nose and tail than the original 6'6"P. A medium tolerance blank.

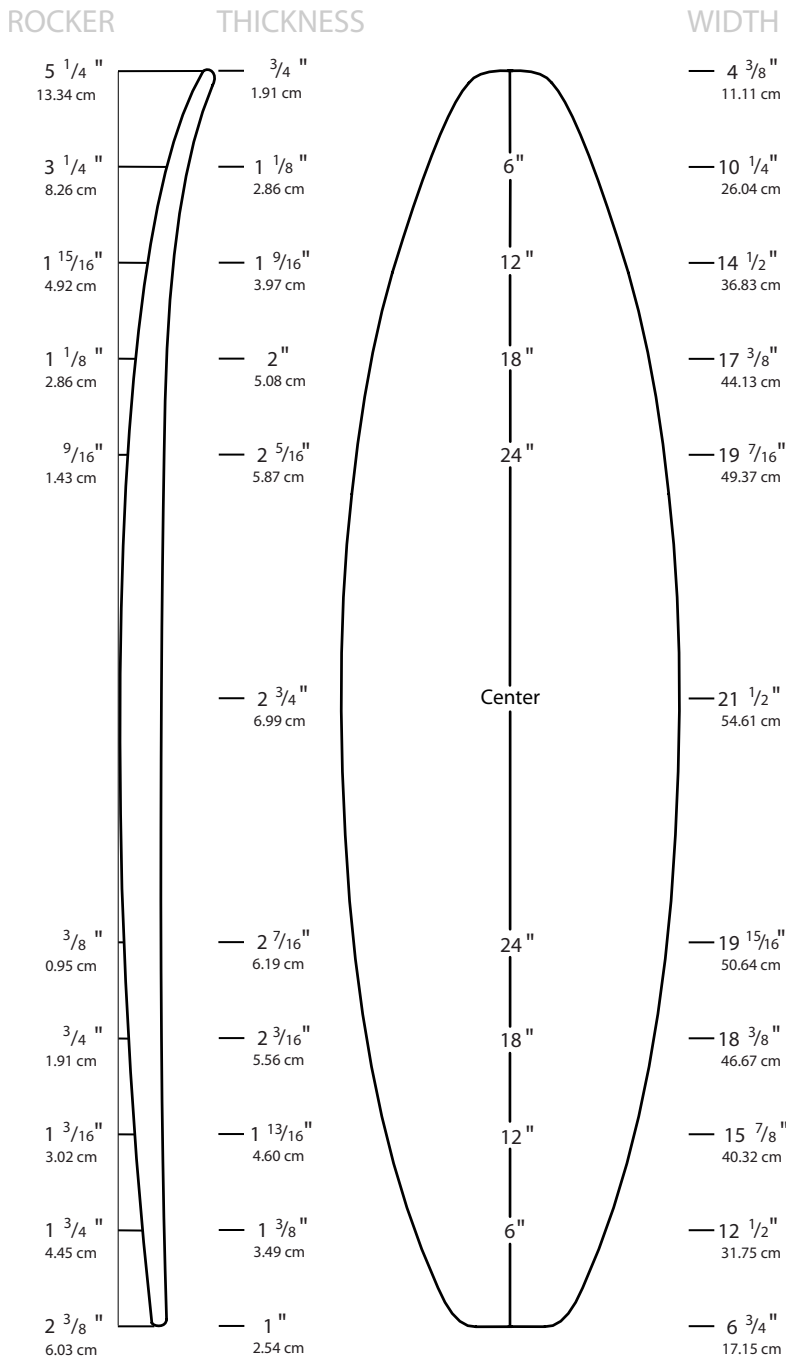

Designed and shaped by: **Timmy Patterson**

Call (310) 225-6774 or visit www.usblanks.com

**68A'X' ALSO AVAILABLE
+ 3/8" THICKER**

6'8" A

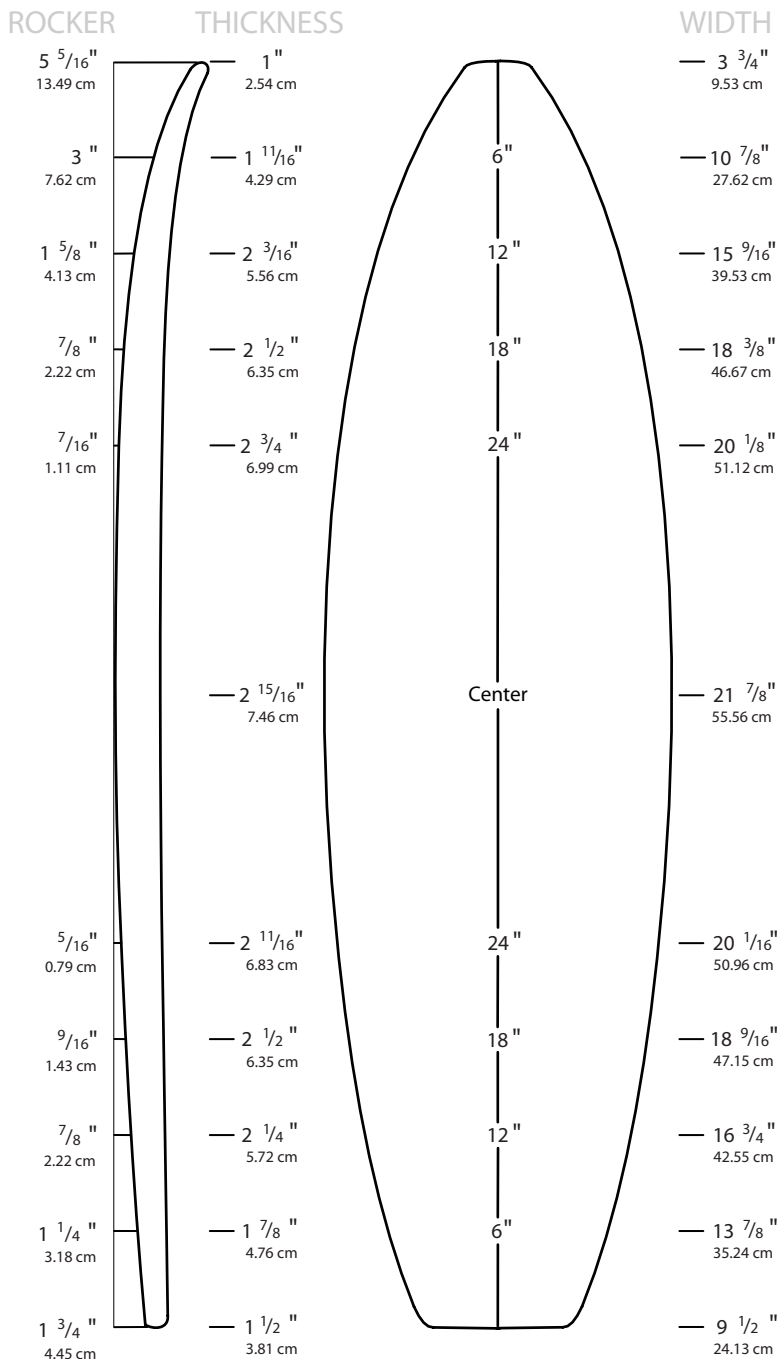

Overall Bottom Length: 6' 7 3/4" (202.57 cm)

Tip-to-tip Deck Length: 6' 7" (200.66 cm)

Maximum Width: 21 7/8" (55.56 cm)

Maximum Thickness: 2 15/16" (7.46 cm)

"X" VERSION AVAILABLE

+3/8" THICKER (3 5/16" CENTER)

Displacement: 1.95 ft³ (55.3 L)

Introduced: July 2006

Available Rockers: Refer to [Rocker Catalog](#)

Shaper's Comments:

I have listened to many people over the years on this one blank. This newly made 6'7"A blank was lengthened to net a 6'7" bottom length. I re-designed the rail shape for less waste and stronger foam, and I also widened the nose @ 12" by 2' 1/2", the wide point by 1/2", and the tail @ 12" by 1", as to be a more useful blank in this size range. The new natural rocker in this mold design is the popular 6'7"A +1/2" nose, +1/4" tail. This rocker being shaped in instead of glued up, will allow for a much more accurate finished rocker, due to no "spring back". I have the old 6'7"A natural rocker if anyone still wants it. All the "A" series blanks are designed to take the majority of thickness off the bottom, leaving small adjustments in the nose and tail rocker and their thicknesses. This blank can be ordered wider or narrower as to allow for stronger decks/rails near the perimeter of the board outline, and less waste.





Call (310) 225-6774 or visit www.usblanks.com

6'8" P

Overall Bottom Length: 6' 7 1/2" (201.93 cm)

Tip-to-tip Deck Length: 6' 6 3/4" (200.03 cm)

Maximum Width: 21 3/8" (54.29 cm)

Maximum Thickness: 2 3/4" (6.99 cm)

Displacement: 1.57 ft³ (44.4 L)

Introduced: July 2006

Available Rockers: Refer to **Rocker Catalog**

Shaper's Comments: Blank is designed for team boards and production shaping. It has slightly adjusted dimensions from the 6'7" P. A medium tolerance blank.

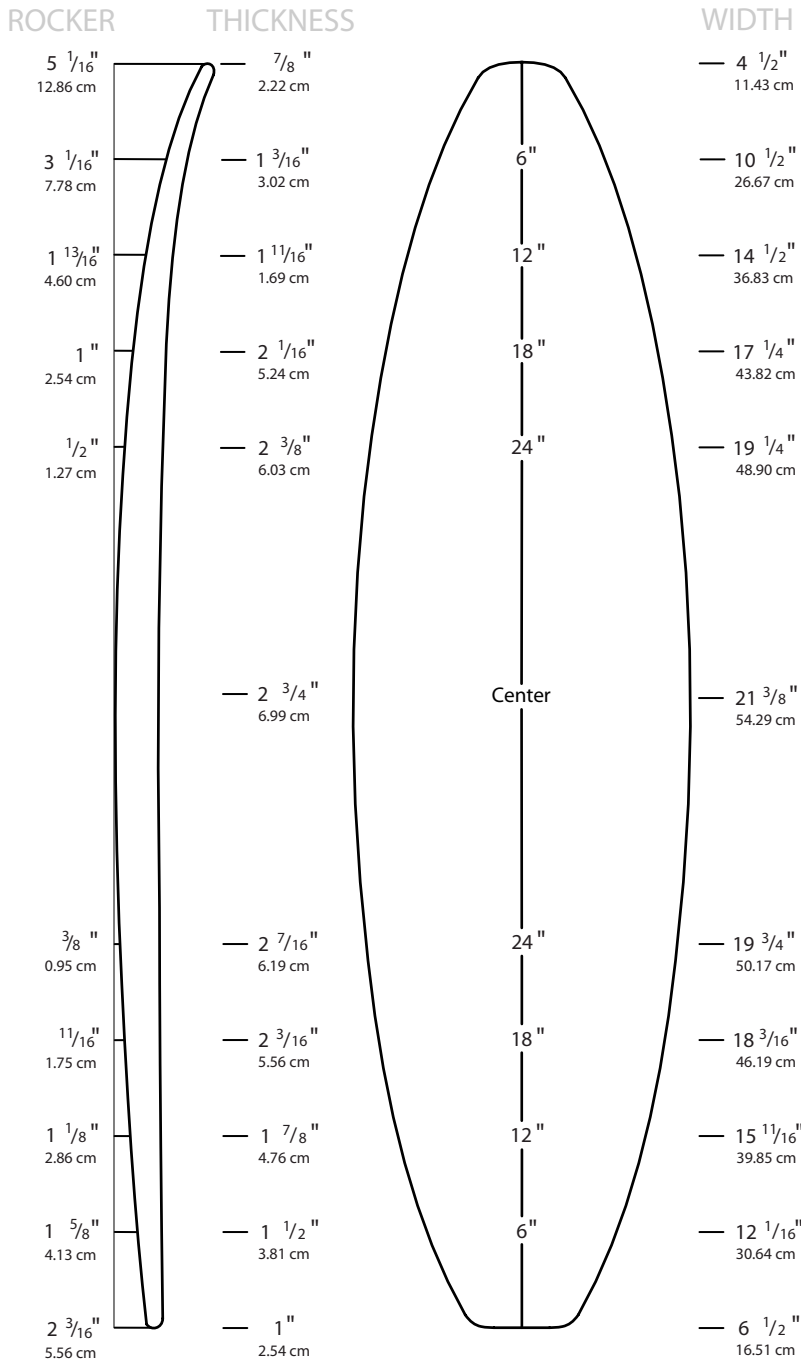

Designed and shaped by: **Timmy Patterson**

Call (310) 225-6774 or visit www.usblanks.com

6'8"RP

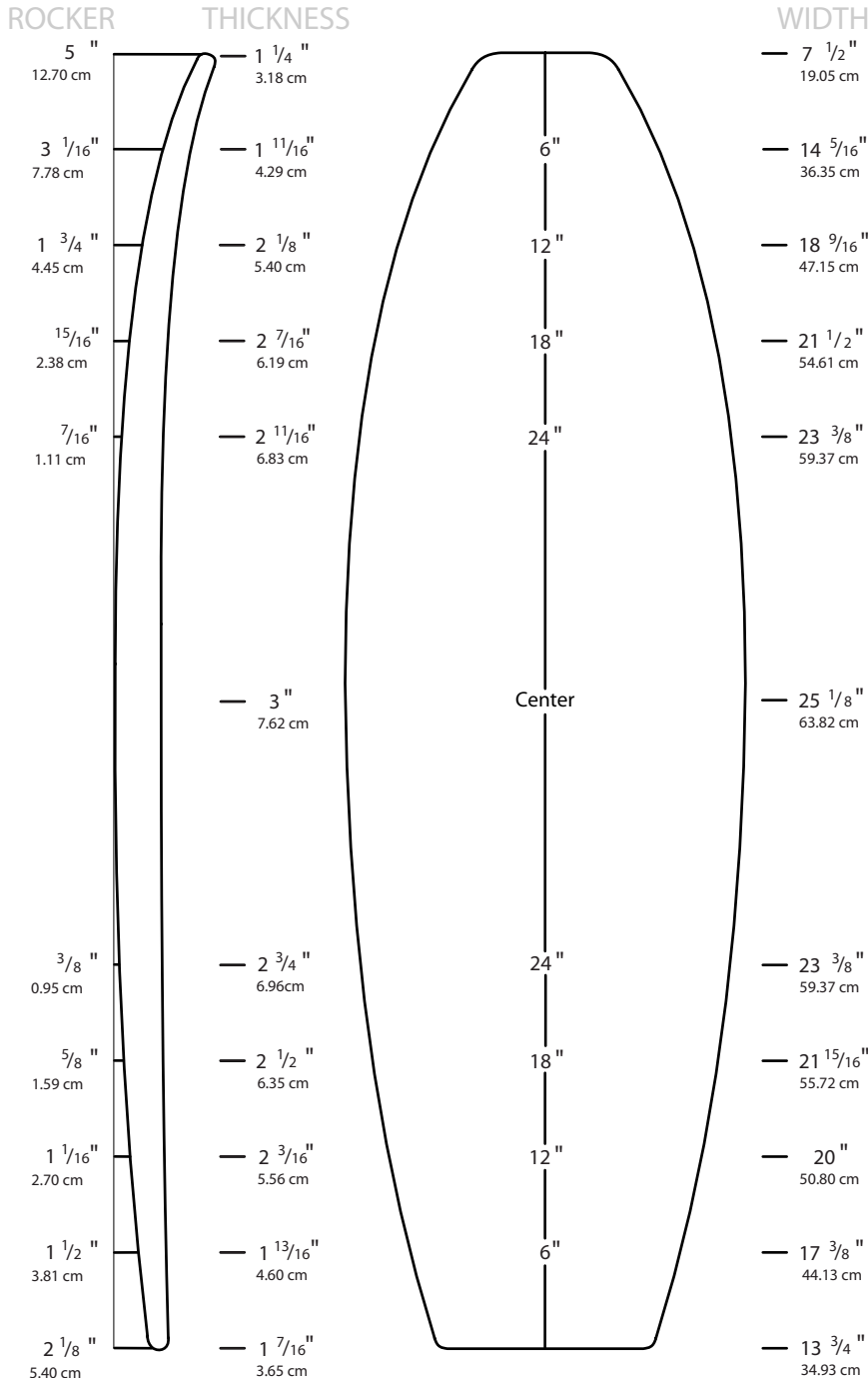

Overall Bottom Length: 6' 9 1/2" (207.01 cm)

Tip-to-tip Deck Length: 6' 8 3/4" (205.11 cm)

Maximum Width: 25 1/8" (63.82 cm)

Maximum Thickness: 3" (7.62 cm)

Displacement: 2.25 ft³ (63.8 L)

Introduced: November 2008. Very versatile. Excellent for contemporary Lis-Fish. Big brother to 5'10"RP. Modified / updated for machine use.

Available Rockers: Refer to **Rocker Catalog**

Shaper's Comments: Designed with input from some of surfing's best designs minds the 6'8"RP is influenced by a universal rocker with profiles that are integrated and timeless. The 6'8"RP will play an important role in the current generation of hand shapers emerging not only as technicians, but also designers at the genesis of what is possible in their craft. This in turn will set a new precedent for the next era of surfing. Paying close attention to and working with all the elements in design in the 6'8"RP opens the door to a new level of performance and self expression for all shapers and designers. Will cleanly net a 6'8" deck measurement with high performance rockers and thickness profiles. Inspired by the modern surfing of Rasta on "the state of the art Lis - Fish".



Designed and shaped by: **Rich Pavel**

Call (310) 225-6774 or visit www.usblanks.com

6'9" EA

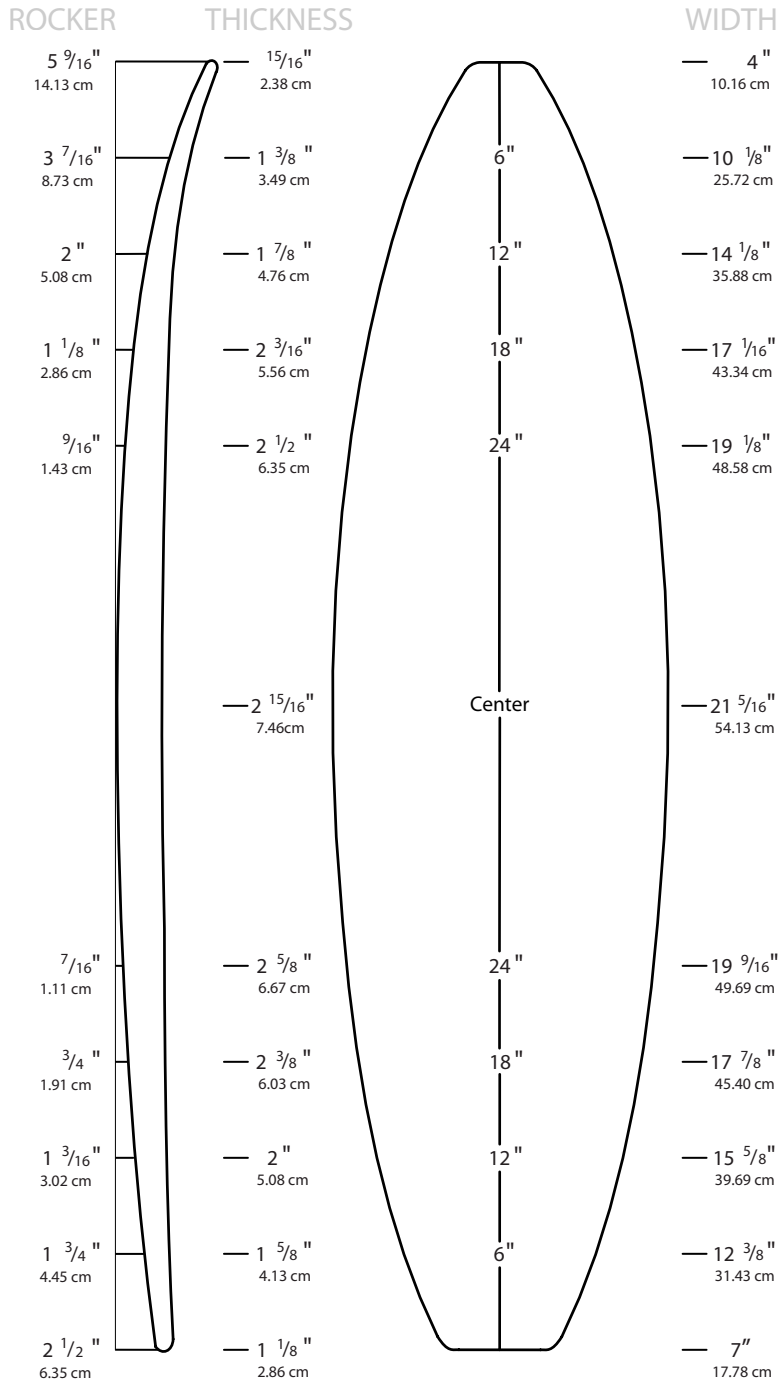

Overall Bottom Length: 6' 9" (205.74 cm)

Tip-to-tip Deck Length: 6' 8" (203.20 cm)

Maximum Width: 21 5/16" (54.13 cm)

Maximum Thickness: 2 15/16" (7.46 cm)

Displacement: 1.71 ft³ (48.3 L)

Introduced: July 2006

Available Rockers: Refer to **Rocker Catalog**

Shaper's Comments: This blank is designed to yield most modern short board designs. The thicker nose and tail give it added versatility for machining. I designed the rocker and foil to accommodate low and full rocker designs.



Call (310) 225-6774 or visit www.usblanks.com

6'10" A

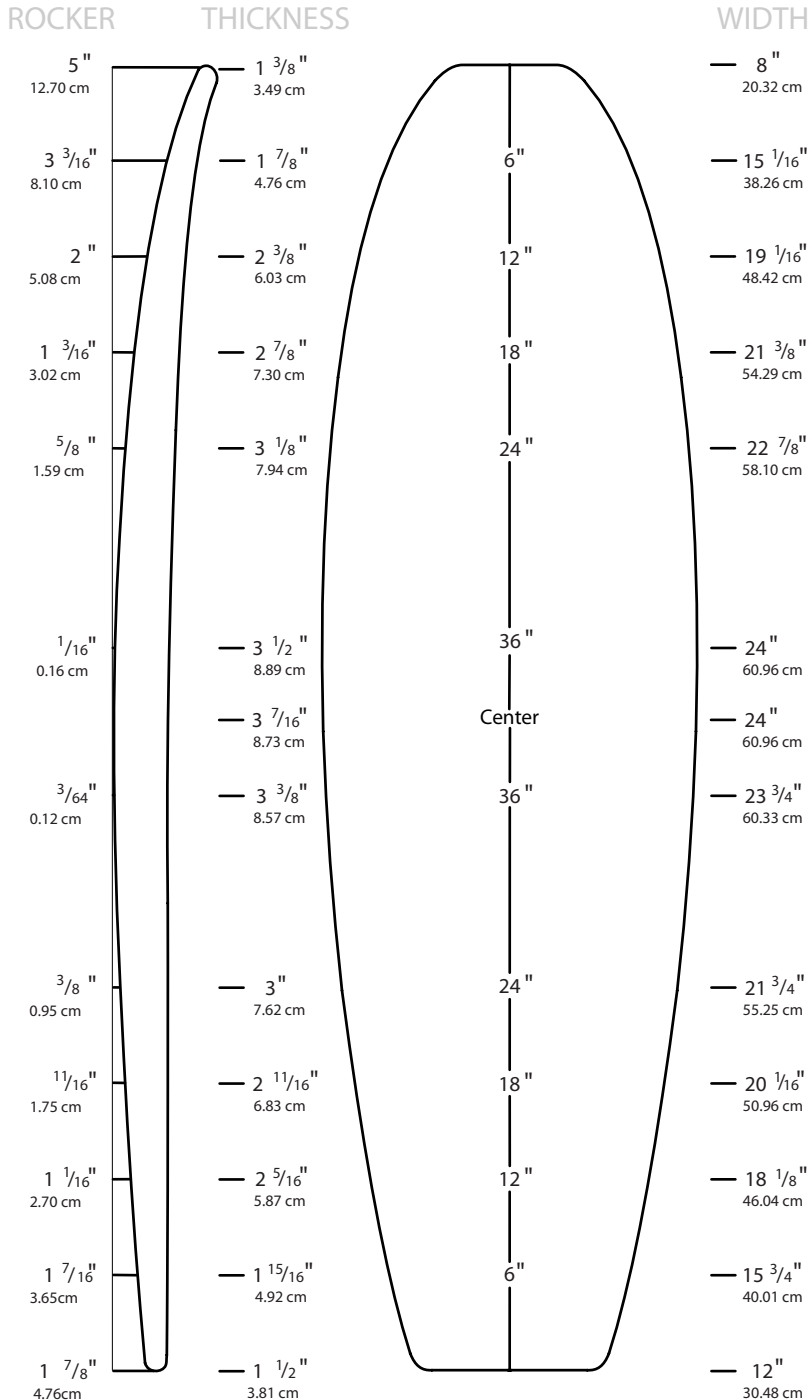

Overall Bottom Length: 6' 10" (208.28 cm)

Tip-to-tip Deck Length: 6' 9 1/2" (207.01 cm)

Maximum Width: 24" (60.96 cm)

Maximum Thickness: 3 1/2" (8.89 cm)

Displacement: 2.52 ft³ (71.4 L)

Introduced: July 2006

Available Rockers: Refer to **Rocker Catalog**

Shaper's Comments: This is the 6'9"A mold design again...same everything! This blank can be ordered wider or narrower as to allow for stronger decks/rails near the perimeter of the board outline, and less waste.



Call (310) 225-6774 or visit www.usblanks.com

7'0" A

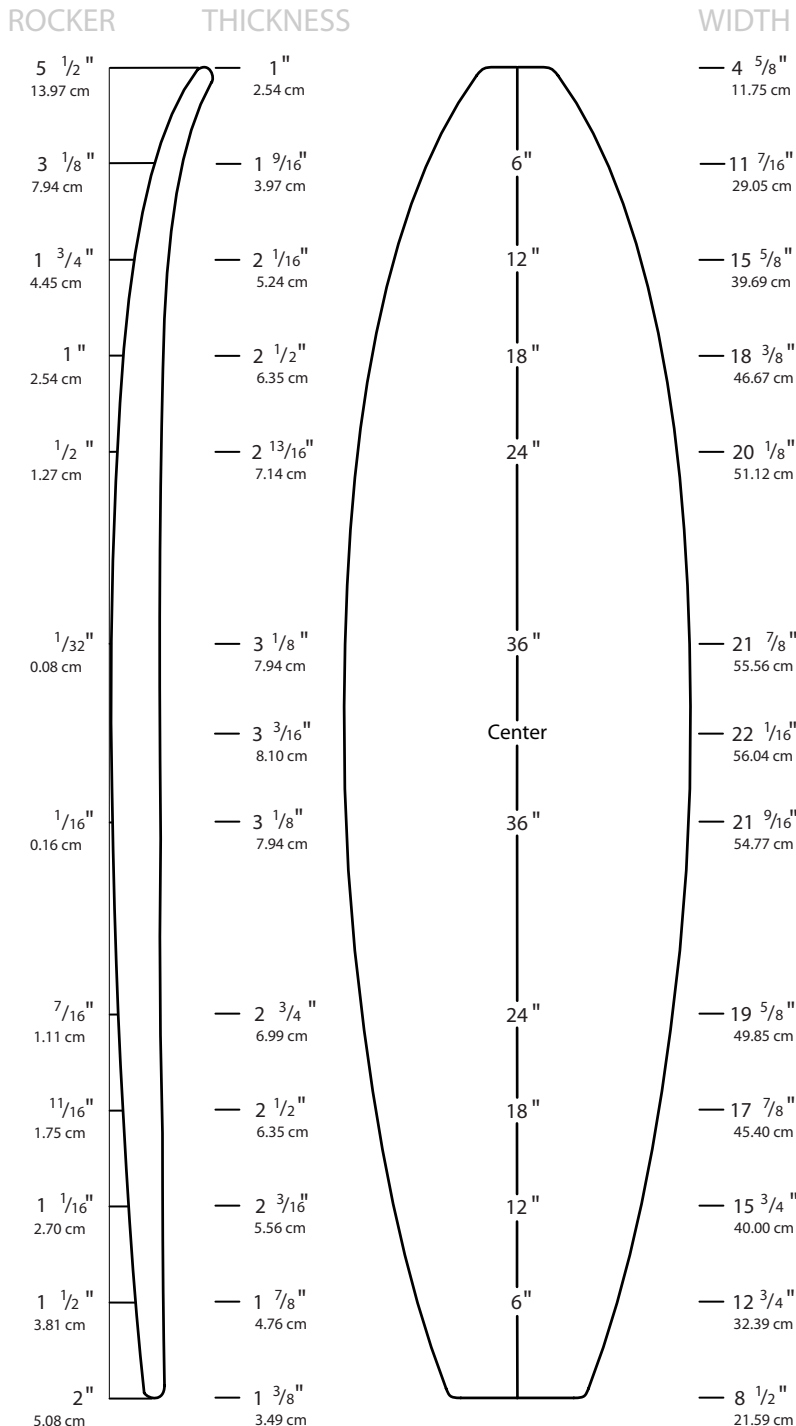

Overall Bottom Length: 6' 11 1/2" (212.09 cm)

Tip-to-tip Deck Length: 6' 10 3/4" (210.19 cm)

Maximum Width: 22 1/8" (56.20 cm)

Maximum Thickness: 3 3/16" (8.10 cm)

Displacement: 2.12 ft³ (60.0 L)

Introduced: July 2006

Available Rockers: Refer to [Rocker Catalog](#)

Shaper's Comments:

This newly made 7'0"A blank is the original 6'11'A lengthened to net a 6'11 bottom length. I re-designed the rail shape for less waste and stronger foam, and I also widened the nose @ 12" by 2 1/2", the wide point by 1/4", and the tail @ 12" by 1", as to be a more useful blank in this size range. The new natural rocker in this mold design is the popular 7'0"A +1/2" nose, +1/2" tail. This rocker being shaped in instead of glued up, will allow for a much more accurate finished rocker, due to no "spring back". The original 6'11"A natural rocker is still available. All the "A" series blanks are designed to take the majority of thickness off the bottom, leaving small adjustments in the nose and tail rocker and their thicknesses. This blank can be ordered wider or narrower as to allow for stronger decks/rails near the perimeter of the board outline, and less waste.



Call (310) 225-6774 or visit www.usblanks.com

7'1" A

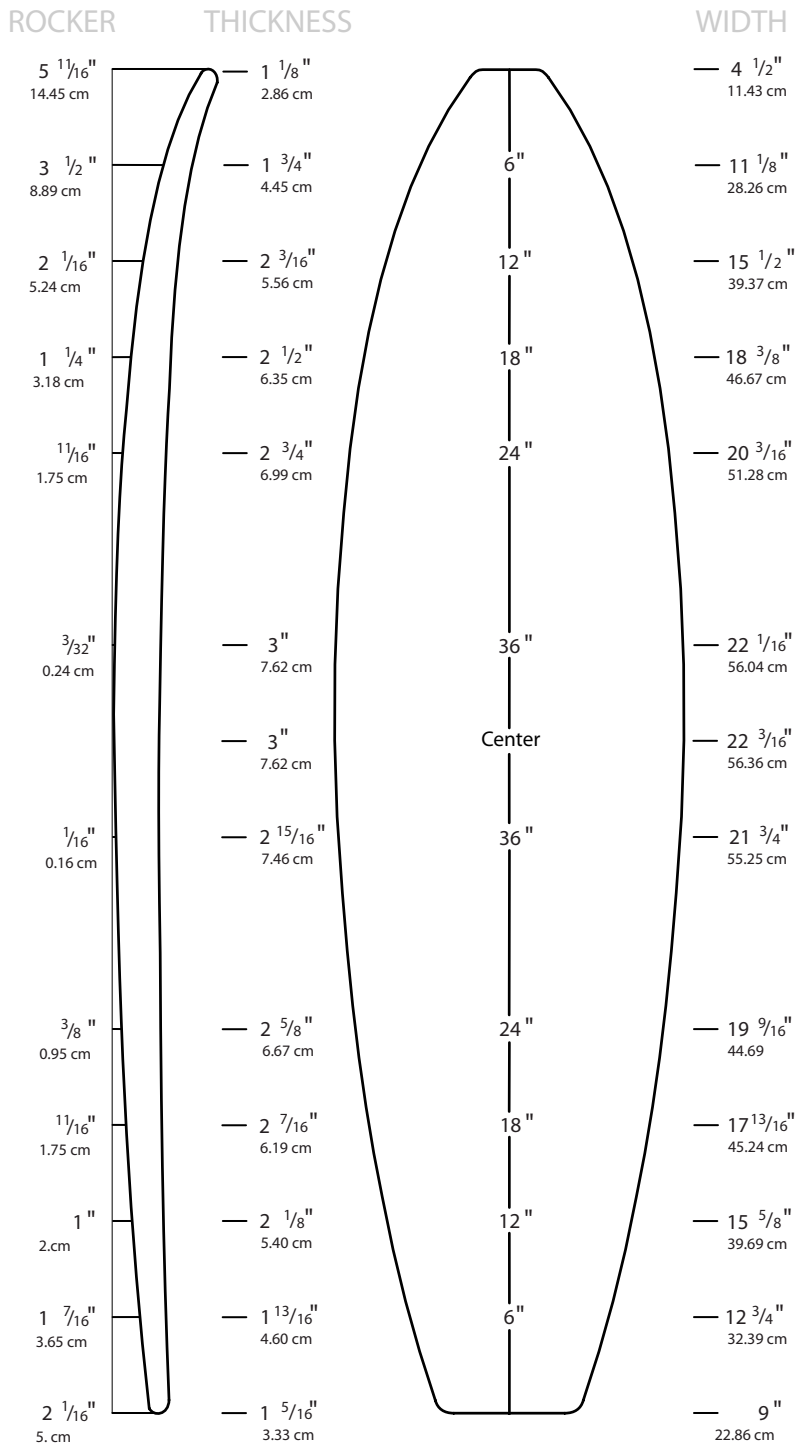

Overall Bottom Length: 7' 0 7/8" (215.58 cm)

Tip-to-tip Deck Length: 6' 11" (213.04 cm)

Maximum Width: 22 3/16" (56.36 cm)

Maximum Thickness: 3" (7.62 cm)

Displacement: 2.05 ft³ (58.1 L)

Introduced: July 2006

Available Rockers: Refer to **Rocker Catalog**

Shaper's Comments:

This newly made 7'1" A blank is the original 7'0" A lengthened to net a 7'0" bottom length. I re-designed the rail shape for less waste and stronger foam, and I also widened the nose @ 12" by 2", the wide point by 3/4", and the tail @ 12" by 1", as to be a more useful blank in this size/volume range. The new natural rocker in this mold design is the popular 70A +1/2" nose, +1/2" tail. This rocker being shaped in instead of glued up, will allow for a much more accurate finished rocker, due to no "spring back". The original 7'0" A natural rocker is still available. All the "A" series blanks are designed to take the majority of thickness off the bottom, leaving small adjustments in the nose and tail rocker and their thicknesses. This blank can be ordered wider or narrower as to allow for stronger decks/rails near the perimeter of the board outline, and less waste.



Call (310) 225-6774 or visit www.usblanks.com

7'1" EA

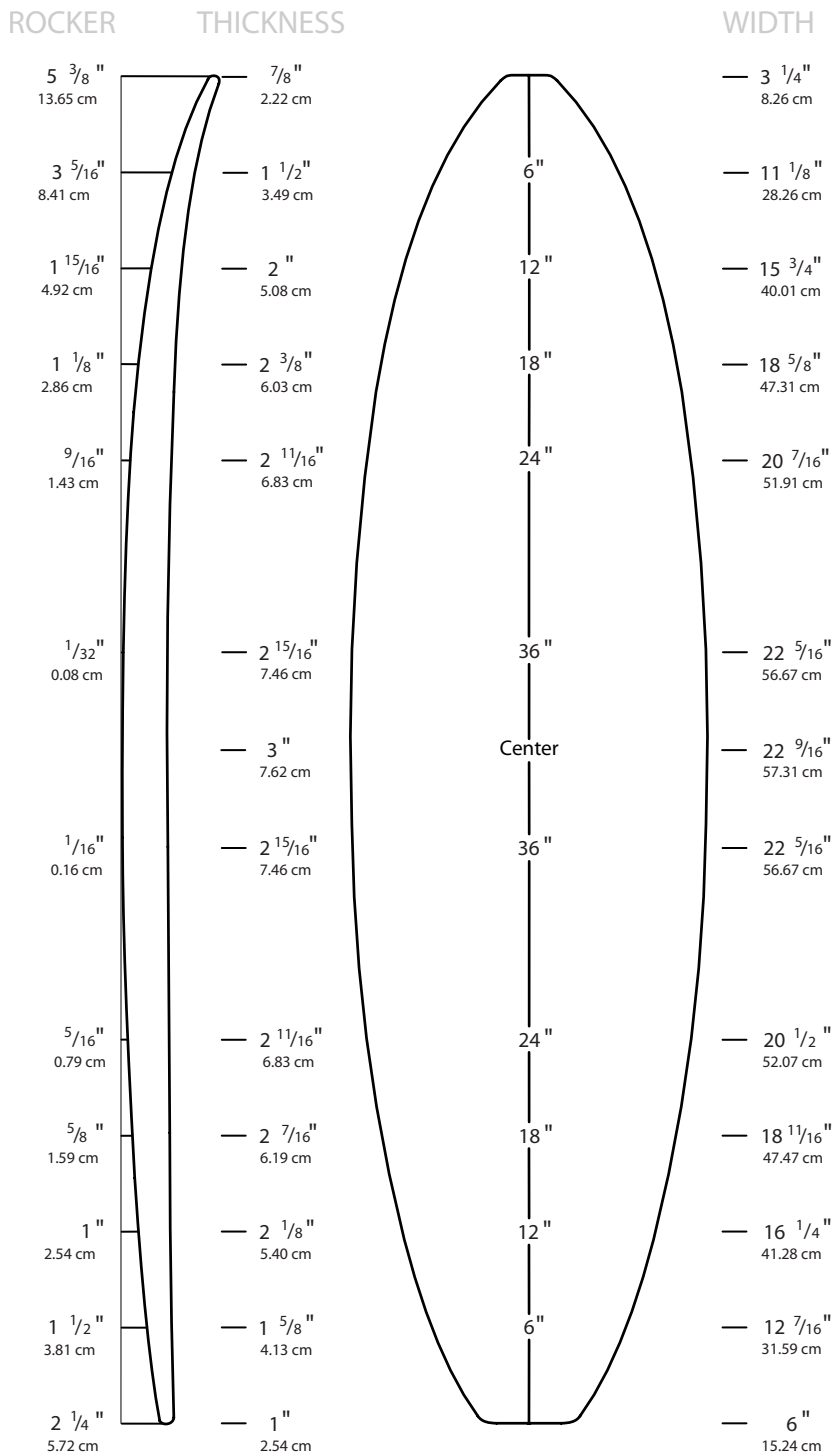

Overall Bottom Length: 7' 0 1/2" (214.63 cm)

Tip-to-tip Deck Length: 6' 11 3/4" (212.73 cm)

Maximum Width: 22 9/16" (57.31 cm)

Maximum Thickness: 3" (7.62 cm)

Displacement: 1.93 ft³ (54.6 L)

Introduced: July 2006

Available Rockers: Refer to **Rocker Catalog**

Shaper's Comments: This is the shorter version of the 7'6" EA.



Call (310) 225-6774 or visit www.usblanks.com

7'2" EA

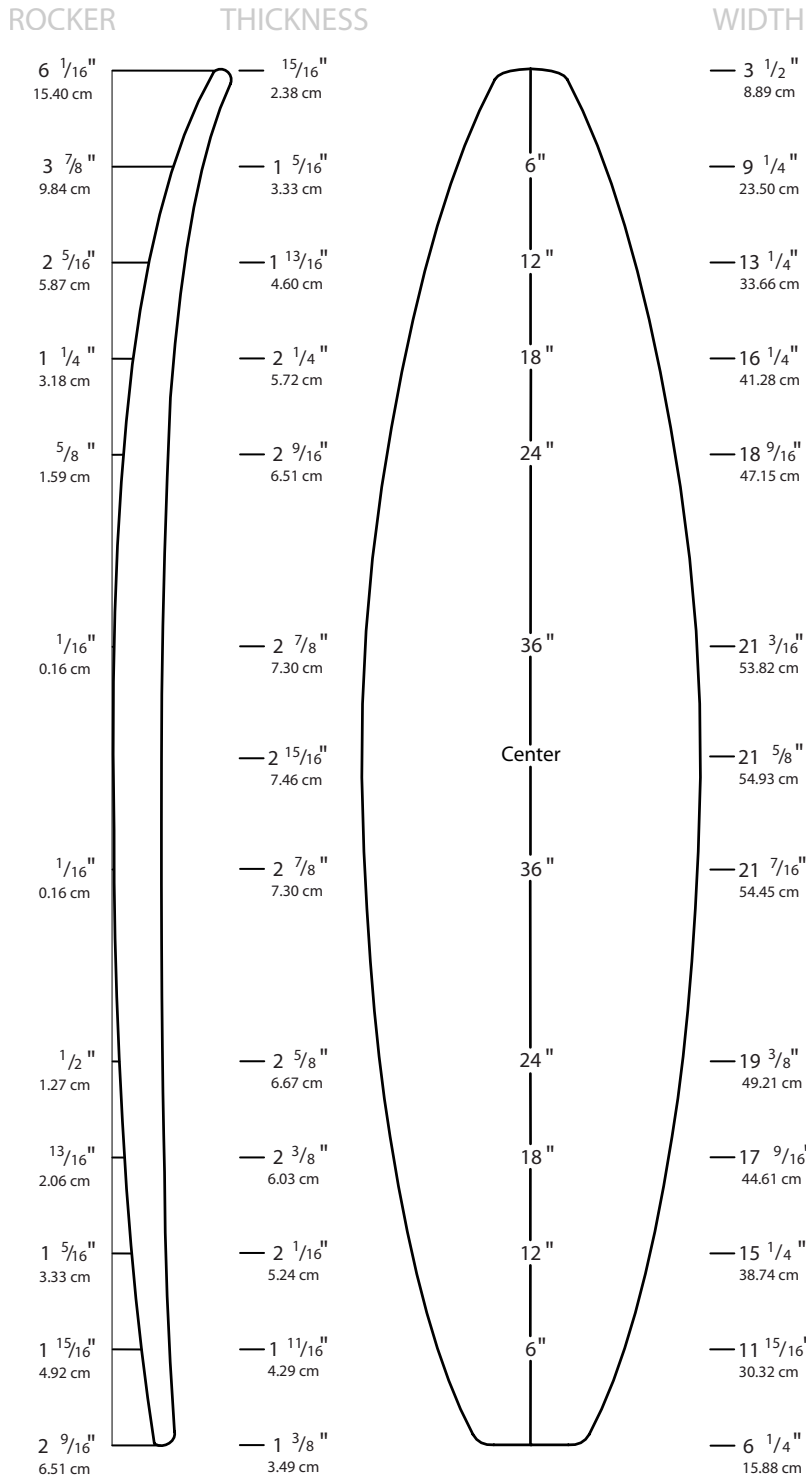

Overall Bottom Length: 7' 2 1/2" (219.71 cm)

Tip-to-tip Deck Length: 7' 1 7/8" (218.12 cm)

Maximum Width: 21 5/8" (54.93 cm)

Maximum Thickness: 2 15/16" (7.46 cm)

Displacement: 1.89 ft³ (53.4 L)

Introduced: April 2007

Available Rockers: Refer to **Rocker Catalog**

Shaper's Comments: This blank is a versatile high performance semi-gun which was designed in series with the 7'8 EA. The rocker and foil will accommodate a wide variety of bottom contours.



Call (310) 225-6774 or visit www.usblanks.com

7'3" A

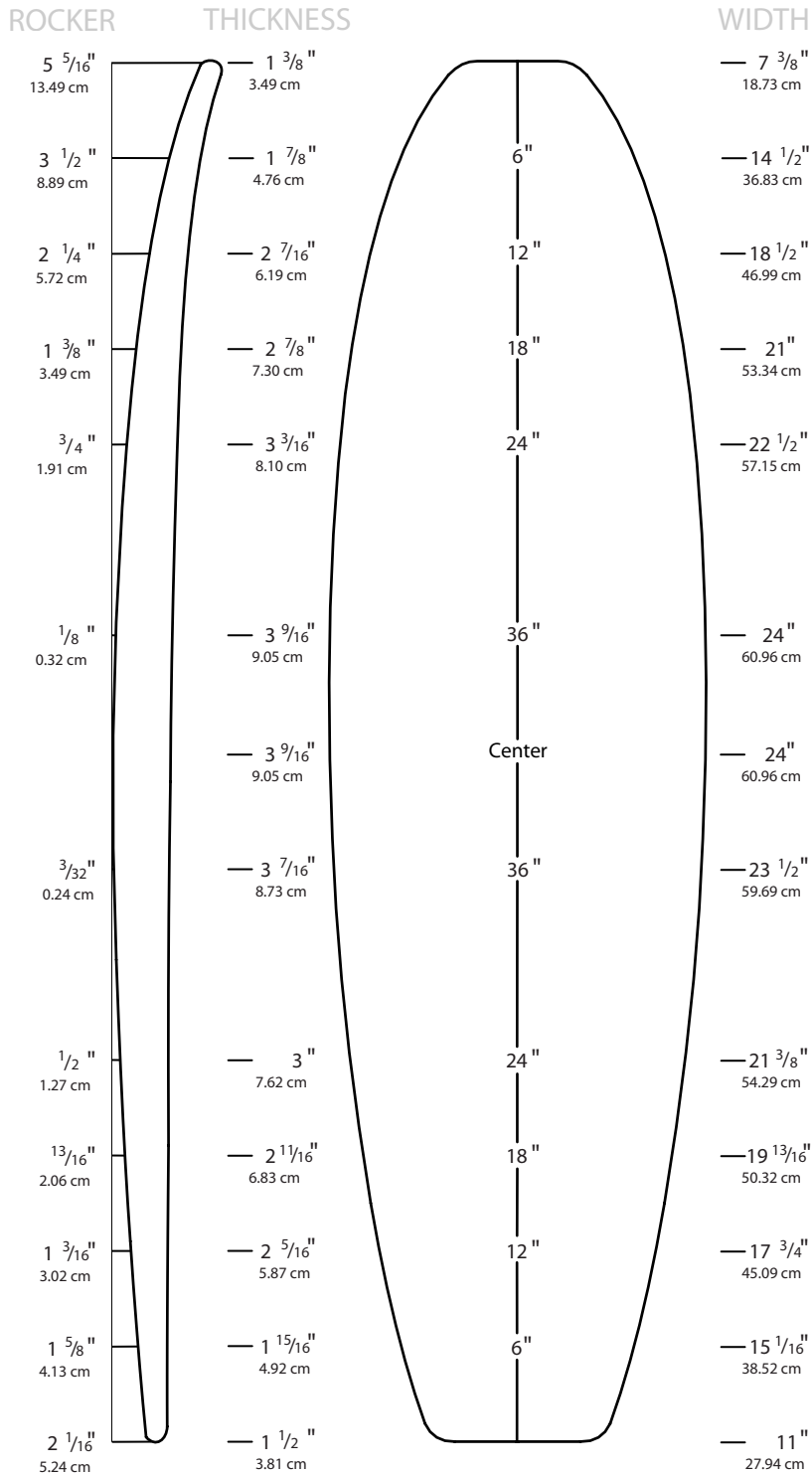

Overall Bottom Length: 7' 2 7/8" (220.66 cm)

Tip-to-tip Deck Length: 7' 2 3/8" (219.39 cm)

Maximum Width: 24" (60.96 cm)

Maximum Thickness: 3 5/8" (9.21 cm)

Displacement: 2.74 ft³ (77.7 L)

Introduced: July 2006

Available Rockers: Refer to [Rocker Catalog](#)

Shaper's Comments: This is my enlarged version of the 6'9"A fish blank. I designed this one as to be able to easily net a 7'3" by the bottom measurement. Bottom rocker is a longer version of the natural rocker of the 6'9"A I made in 2002. I basically "blew up" the 6'9"A concept for this mold design. This blank can be ordered wider or narrower as to allow for stronger decks/rails near the perimeter of the board outline, and less waste.



Call (310) 225-6774 or visit www.usblanks.com

7'4" SP

ROCKER

THICKNESS

WIDTH

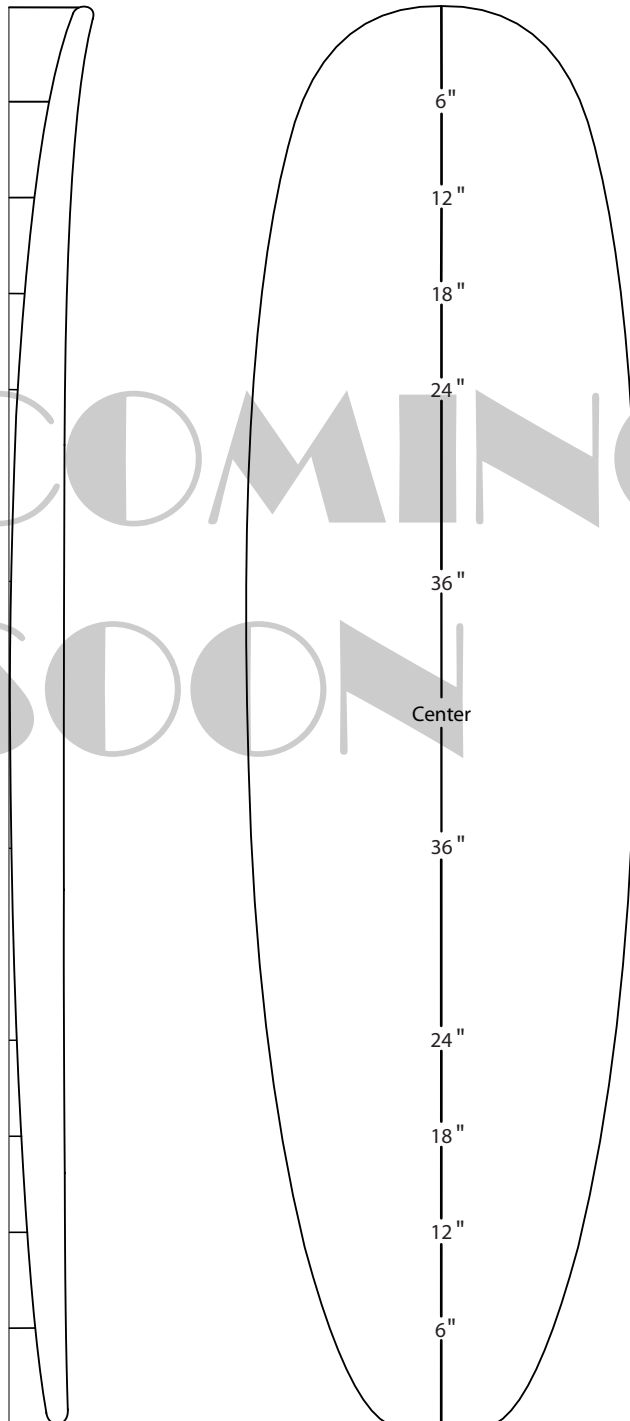

COMING
SOON

Overall Bottom Length: #' # #/#" (###.## cm)

Tip-to-tip Deck Length: #' # #/#" (###.## cm)

Maximum Width: # #/#" (##.## cm)

Maximum Thickness: # #/#" (##.## cm)

Displacement: #.### cubic feet (##.##### L)

Introduced: June 2014

Rockers: Natural

Shaper's Comments: Forthcoming



Designed and shaped by: **Charlie Smith & Tom Parrish**

Call (310) 225-6774 or visit www.usblanks.com

7'5" A

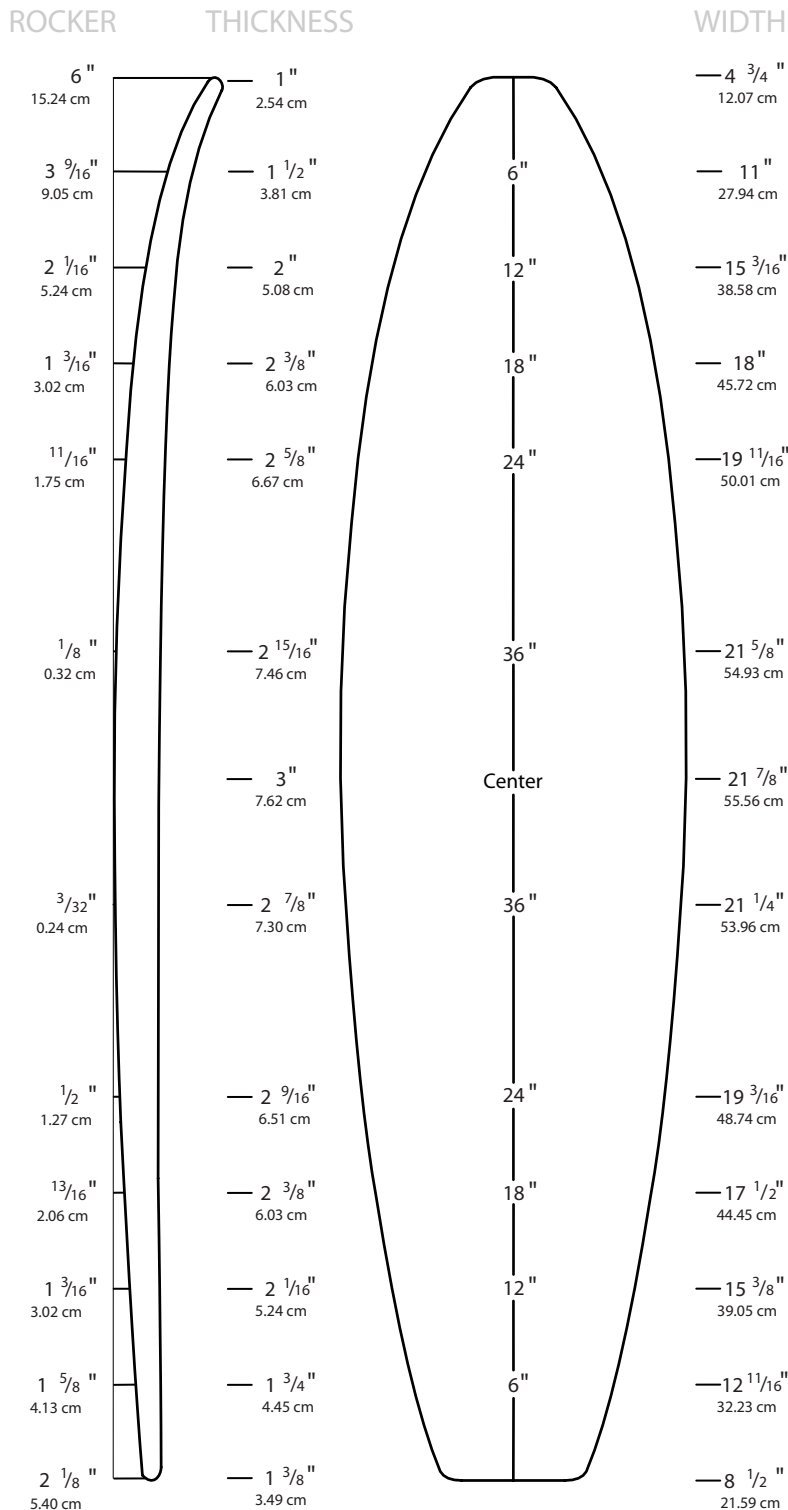

Overall Bottom Length: 7' 4 1/2" (224.79 cm)

Tip-to-tip Deck Length: 7' 3 7/16" (222.09 cm)

Maximum Width: 21 7/8" (55.56 cm)

Maximum Thickness: 3" (7.62 cm)

Displacement: 2.13 ft³ (60.2 L)

Introduced: July 2006

Available Rockers: Refer to **Rocker Catalog**

Shaper's Comments:

This newly made 7'5"A blank is the original 7'3"A lengthened to easily net a 7'4" bottom length. I re-designed the rail shape for less waste and stronger foam, and I also widened the nose @ 12" by 2", the wide point by 3/8", and the tail @ 12" by 1", as to be a more useful blank in this size/volume range. The new natural rocker in this mold design is the 7'3"A +1/2" nose, +3/8" tail. This rocker being shaped in instead of glued up, will allow for a much more accurate finished rocker, due to no "spring back". We have the old 7'3"A natural rocker if anyone still wants it. All the "A" series blanks are designed to take the majority of thickness off the bottom, leaving small adjustments in the nose and tail rocker and their thicknesses. This blank can be ordered wider or narrower as to allow for stronger decks/rails near the perimeter of the board outline, and less waste.



Call (310) 225-6774 or visit www.usblanks.com

7'6" EA

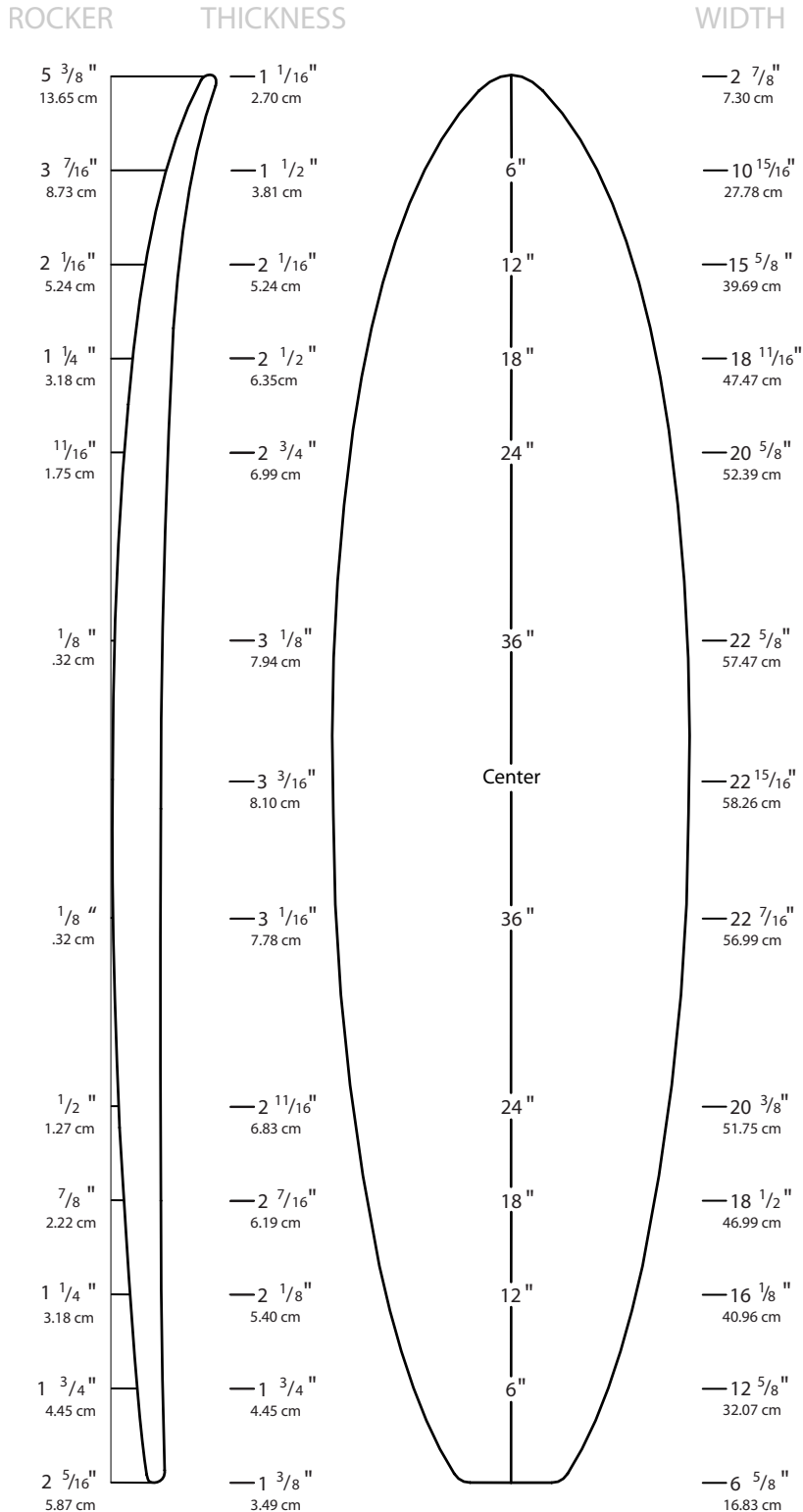

Overall Bottom Length: 7' 6" (228.60 cm)

Tip-to-tip Deck Length: 7' 5 3/8" (227.01 cm)

Maximum Width: 23" (58.42 cm)

Maximum Thickness: 3 3/16" (8.10 cm)

Displacement: 2.28 ft³ (64.6 L)

Introduced: July 2006

Available Rockers: Refer to **Rocker Catalog**

Shaper's Comments: This is primarily designed for making fun boards. It comes with a moderate but continuous even rocker and foil to make "positioning" the blank for the shape process easy.



Call (310) 225-6774 or visit www.usblanks.com

7'7" A

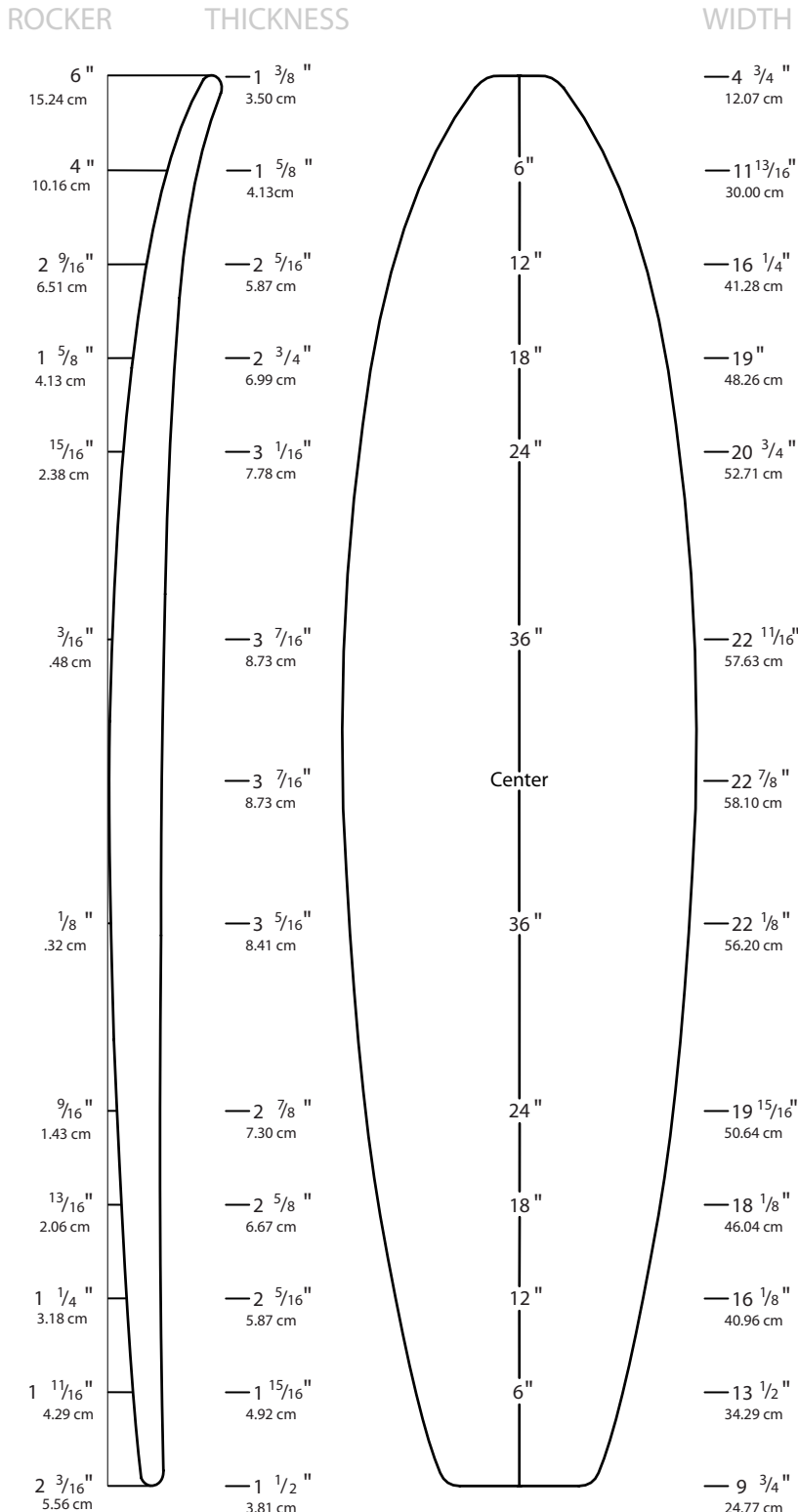

Overall Bottom Length: 7' 6 5/8" (230.19 cm)

Tip-to-tip Deck Length: 7' 6" (228.60 cm)

Maximum Width: 22 7/8" (58.10 cm)

Maximum Thickness: 3 7/16" (8.73 cm)

Displacement: 2.63 ft³ (74.6 L)

Introduced: July 2006

Available Rockers: Refer to **Rocker Catalog**

Shaper's Comments:

This newly made 7'7" A blank is the original 7'5" A lengthened to easily net a 7'6" bottom length. I re-designed the rail shape for less waste and stronger foam and also widened the nose @ 12" by 2", the wide point by 1", and the tail @ 12" by 1", as to be a more useful blank in this size/volume range. The new natural rocker in this mold design is the 7'5" A +1/2" nose, +3/8" tail. This rocker being shaped in instead of glued up, will allow for a much more accurate finished rocker, due to no "spring back". We have the old 7'5" A natural rocker if anyone still wants it. All the "A" series blanks are designed to take the majority of thickness off the bottom, leaving small adjustments in the nose and tail rocker and their thicknesses. This blank can be ordered wider or narrower as to allow for stronger decks/rails near the perimeter of the board outline, and less waste.



Call (310) 225-6774 or visit www.usblanks.com

7'8" EA

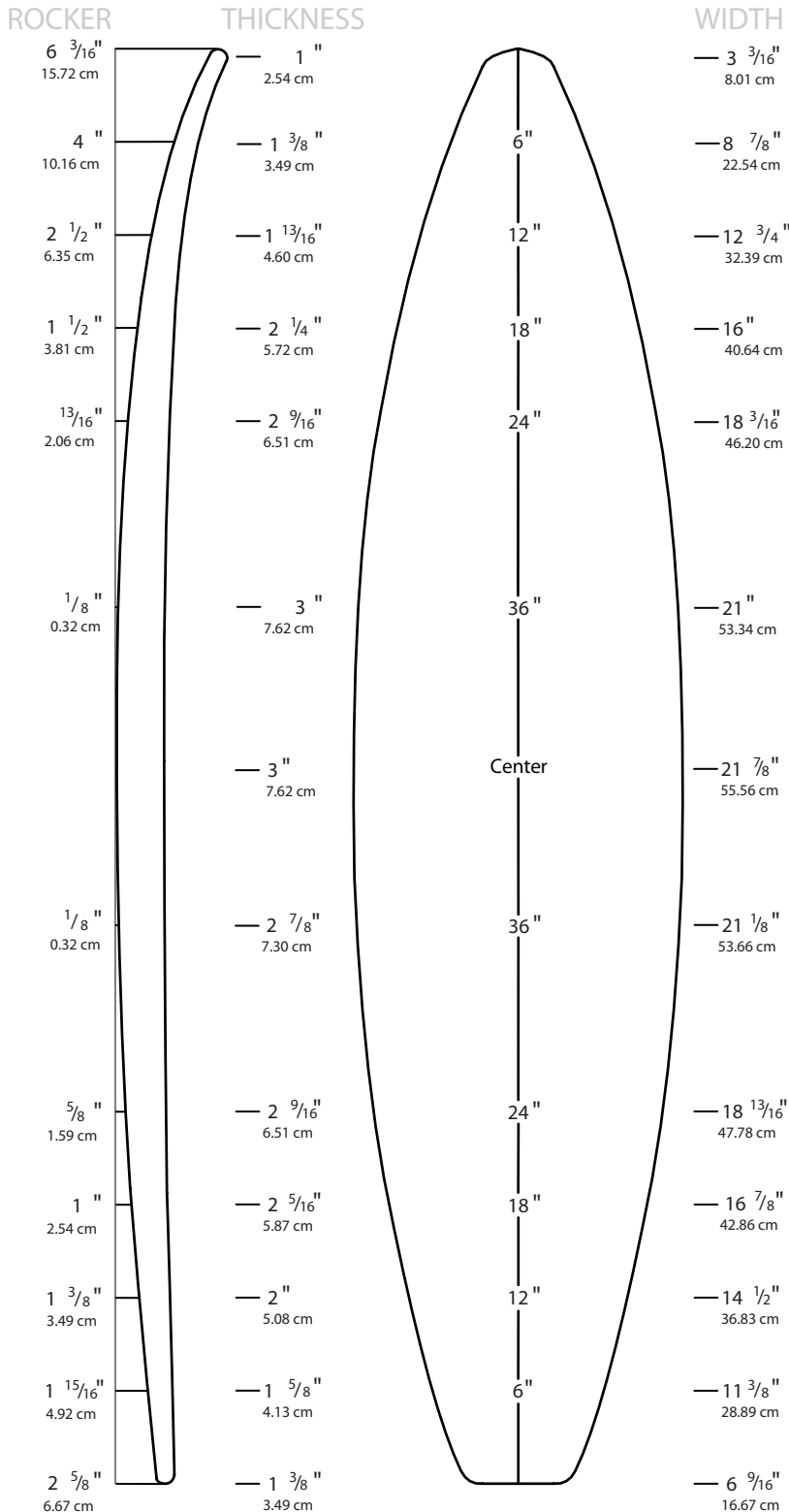

Overall Bottom Length: 7' 9" (236.22 cm)

Tip-to-tip Deck Length: 7' 8 3/16" (234.16 cm)

Maximum Width: 21 7/8" (55.56 cm)

Maximum Thickness: 3" (7.62 cm)

Displacement: 2.03 ft³ (57.5 L)

Introduced: June 2007

Available Rockers: Refer to **Rocker Catalog**

Shaper's Comments: Designed in series with the 7'2 EA to yield guns in the 7'0 to 7'7 range.





7'9"H

**79H'X' ALSO AVAILABLE
+ 3/8" THICKER**

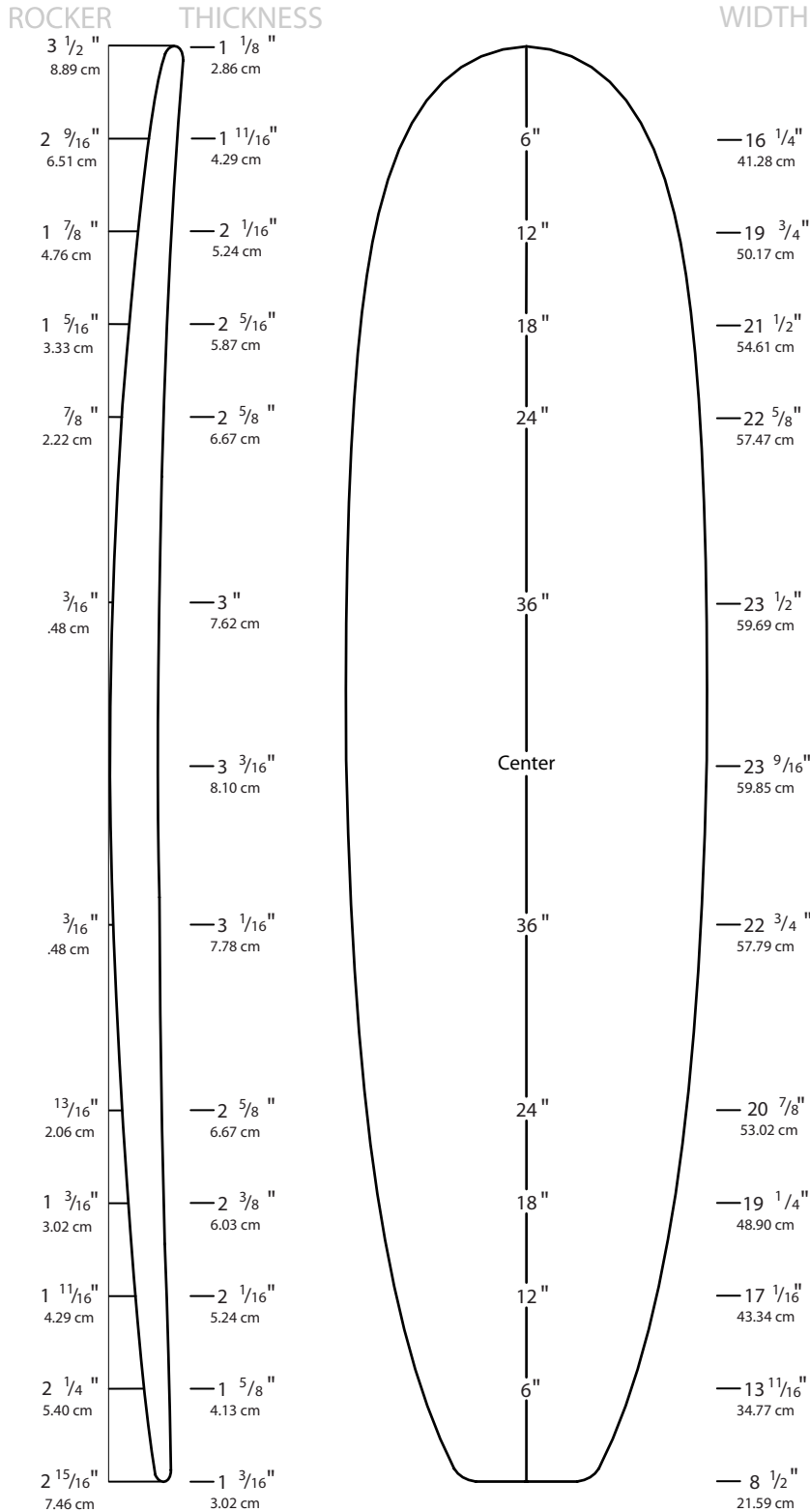

Overall Bottom Length: 7' 8 5/8" (235.27 cm)

Tip-to-tip Deck Length: 7' 8 3/8" (234.63 cm)

Maximum Width: 23 9/16" (59.85 cm)

Maximum Thickness: 3 3/16" (8.10 cm)

"X" VERSION ALSO AVAILABLE

+3/8" THICKER

Displacement: 2.51 ft³ (71.2 L)

Introduced: July 2006

Available Rockers: Refer to [Rocker Catalog](#)

Shaper's Comments: Designed for retro fun-shapes. Based on feedback from 7'11"H and 8'4"H, improvements were made in the thickness and foil. Should accommodate many rockers and be an easy hand or machine shape blank.



Designed and shaped by: Roger Hinds

Call (310) 225-6774 or visit www.usblanks.com

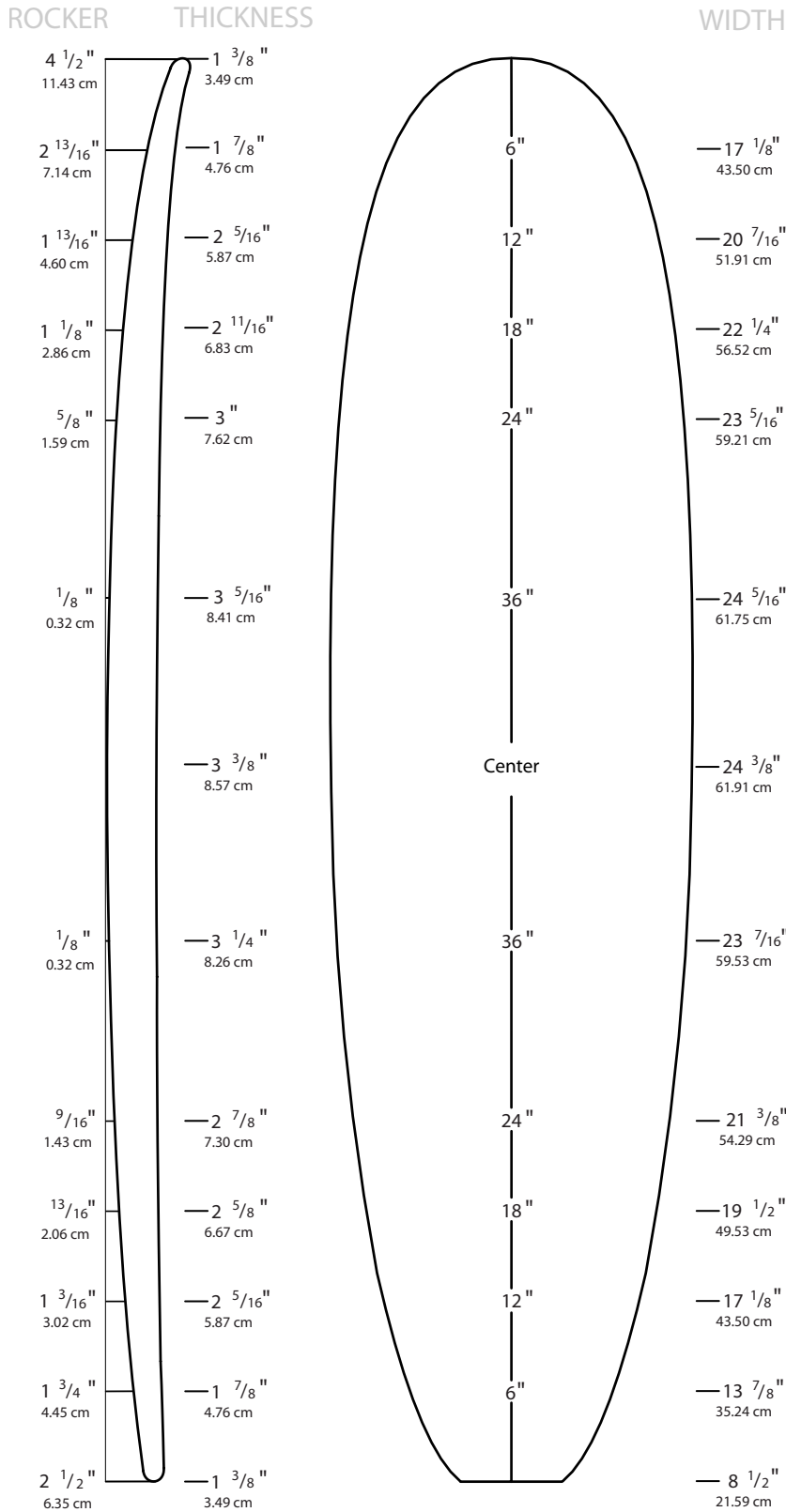

Overall Bottom Length: 7' 11 1/4" (241.94 cm)

Tip-to-tip Deck Length: 7' 10 3/4" (240.67 cm)

Maximum Width: 24 3/8" (61.91 cm)

Maximum Thickness: 3 3/8" (8.57 cm)

Displacement: 2.892 cubic feet (81.9 L)

Introduced: May 2014

Rockers: Natural

Shaper's Comments: Forthcoming

NEW RELEASE !!



Call (310) 225-6774 or visit www.usblanks.com

7'11" A

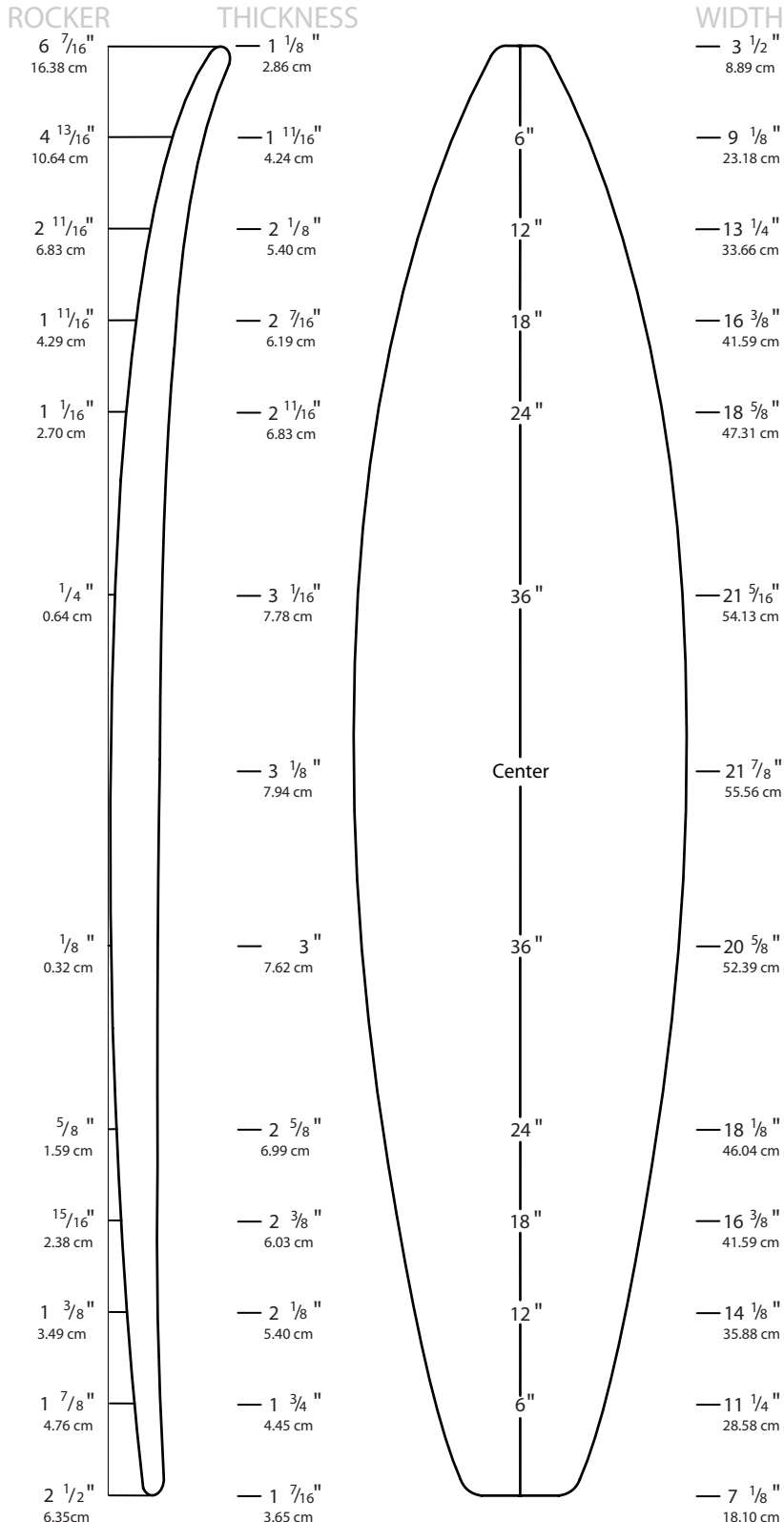

- Overall Bottom Length:** 7' 11 1/2" (242.57 cm)
- Tip-to-tip Deck Length:** 7' 10 11/16" (240.51 cm)
- Maximum Width:** 21 7/8" (55.56 cm)
- Maximum Thickness:** 3 1/8" (7.94 cm)
- Displacement:** 2.32 ft³ (65.7 L)
- Introduced:** September 2006
- Available Rockers:** Refer to **Rocker Catalog**
- Shaper's Comments:**

This newly made 7'11"A blank was lengthened to easily net a 7'10" bottom length. I redesigned the rail shape for less waste and stronger foam. I also widened the nose @12" by 1/2", the wide point by 3/8", and the tail @12" by 1/2", as to be a more useful blank in this size/volume range. The new natural rocker in this mold design is the 7'11"A +1/2" nose, +3/8" tail. This rocker being shaped in instead of glued up, will allow for a much more accurate finished rocker, due to no "spring back." I have the old 7'11"A natural rocker if anyone still wants it. All the "A" series blanks are designed to take the majority of thickness of the bottom, leaving small adjustments in the nose and tail rocker and their thicknesses. This blank can be ordered wider or narrower as to allow for stronger decks/rails near the perimeter of the board outline, and less waste.



Call (310) 225-6774 or visit www.usblanks.com

8'0"H

Overall Bottom Length: 8' 0 1/8" (244.16 cm)

Tip-to-tip Deck Length: 7' 11 5/8" (242.89 cm)

Maximum Width: 23 5/8" (60.01 cm)

Maximum Thickness: 3 5/16" (8.41 cm)

Displacement: 2.77 ft³ (78.4 L)

Introduced: July 2006

Available Rockers: Refer to **Rocker Catalog**

Shaper's Comments: Designed for retro fun-shapes. Based on feedback from 7'11"H and 8'4"H, improvements were made in the thickness and foil. Should accomodate many rockers and be an easy hand or machine shape blank.

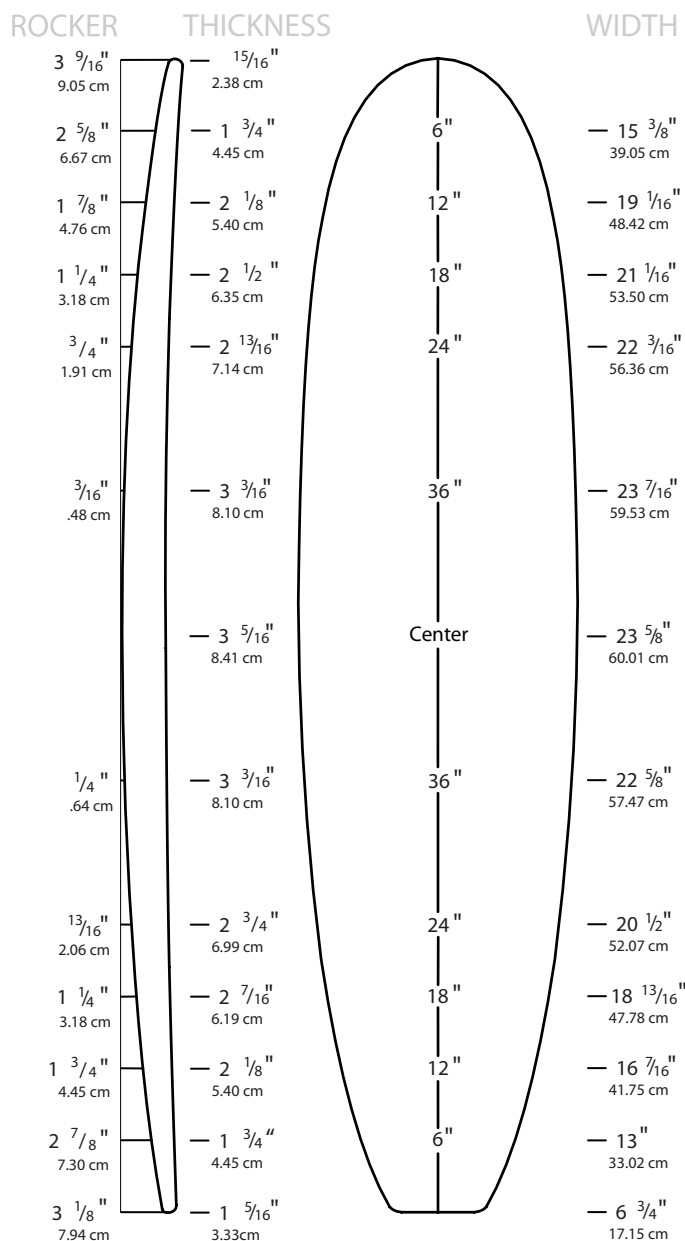

Call (310) 225-6774 or visit www.usblanks.com

8'1" EA

Overall Bottom Length: 8' 0 5/8" (245.43 cm)

Tip-to-tip Deck Length: 7' 11 3/4" (243.21 cm)

Maximum Width: 24 1/16" (61.19 cm)

Maximum Thickness: 3 3/8" (8.57 cm)

Displacement: 2.66 ft³ (75.3 L)

Introduced: July 2006

Available Rockers: Refer to **Rocker Catalog**

Shaper's Comments: This is the bigger version of the 7'6" EA. I added width forward to accommodate wider noses.

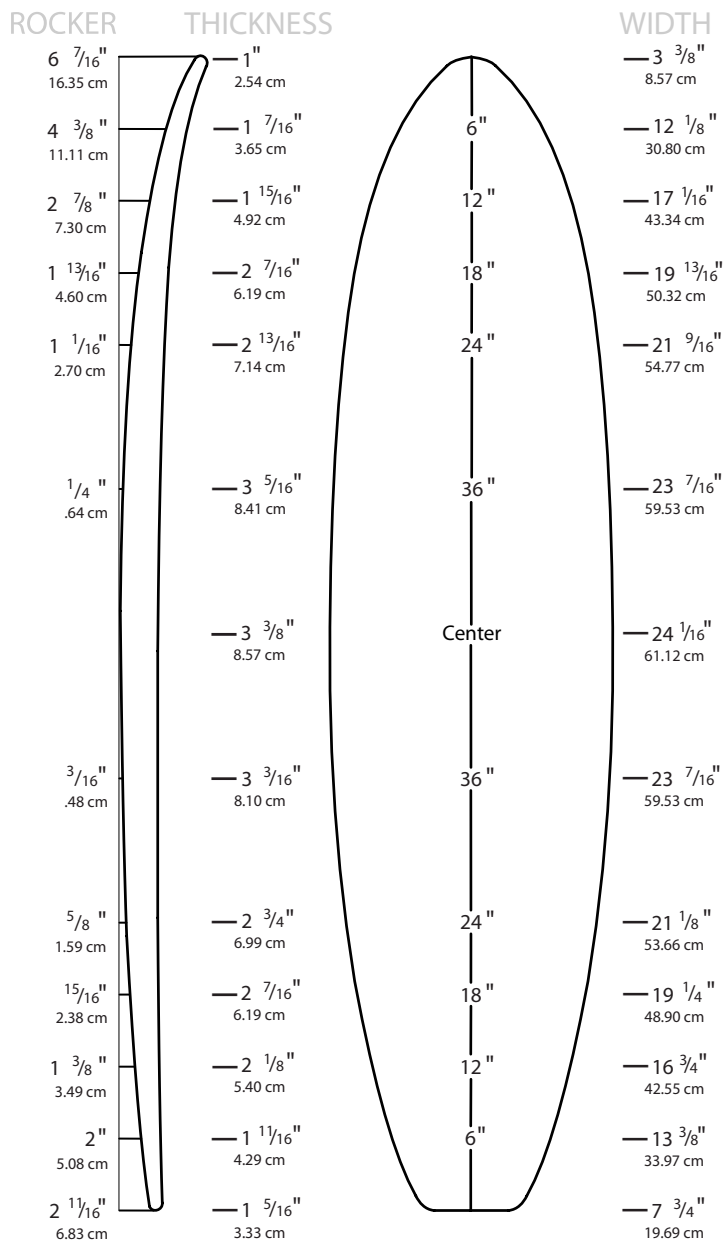

Call (310) 225-6774 or visit www.usblanks.com

**82A'X' ALSO AVAILABLE
+ 3/8" THICKER**

8'2" A

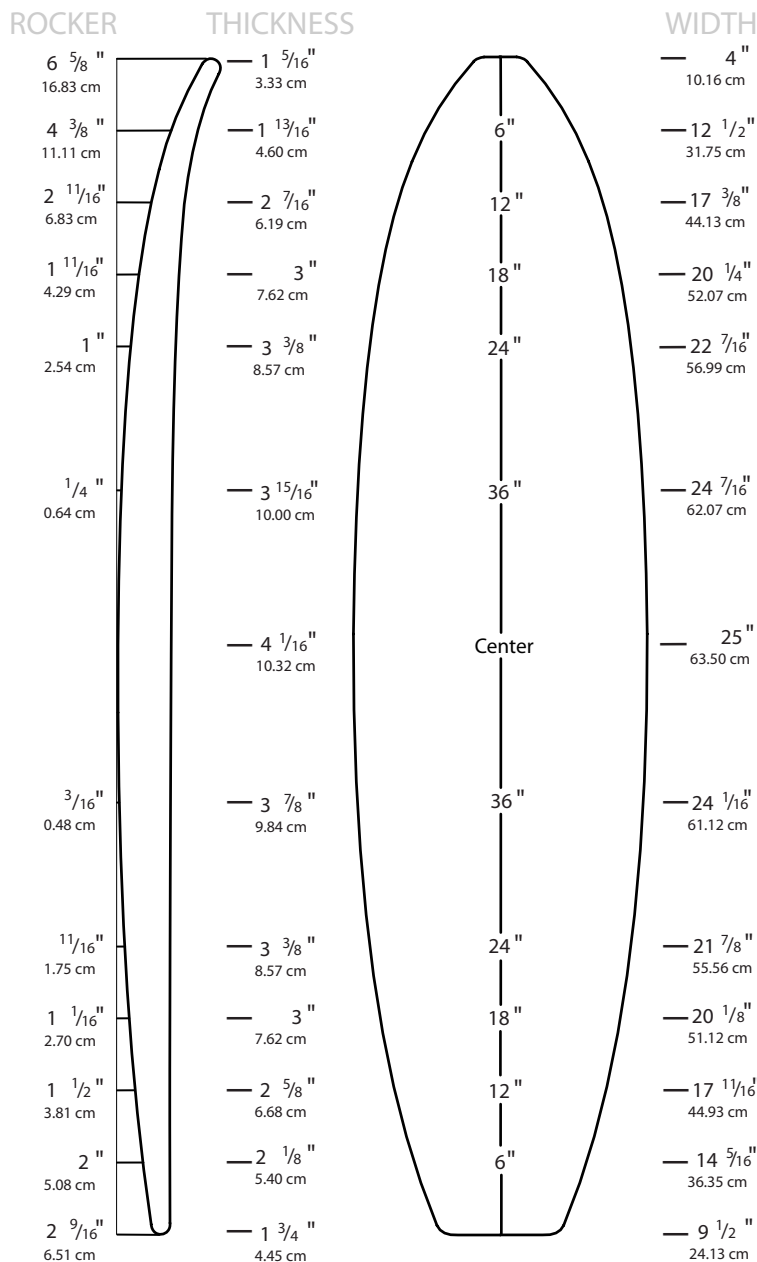

Overall Bottom Length: 8' 2 1/2" (250.19 cm)

Tip-to-tip Deck Length: 8' 1 1/2" (247.65 cm)

Maximum Width: 25" (63.50 cm)

Maximum Thickness: 4 1/16" (10.32 cm)

"X" VERSION ALSO AVAILABLE

+3/8" THICKER

Displacement: 3.59 ft³ (101.7 L)

Introduced: July 2008

Available Rockers: Refer to [Rocker Catalog](#)

Shaper's Comments: I designed the 8'2A to be a serious "big guy" blank for either high performance, retro's, or fun gun styles. I desinged this blank with a performance bottom curve and enough volume for 300 lb. surfers. It should be able to yield 8'0 x 24 x 3 3/4 with ability to position the overall rocker and nose widths as needed. Cutting 2" length off the nose will enable a 18 1/2" nose width at 12" back, and facilitate well for big guy fish designs. **MY SPECIAL THANKS TO BEN AIPA** who provided inspiration on the overall design of this blank and the new 9'3A.



Call (310) 225-6774 or visit www.usblanks.com

8'3"H

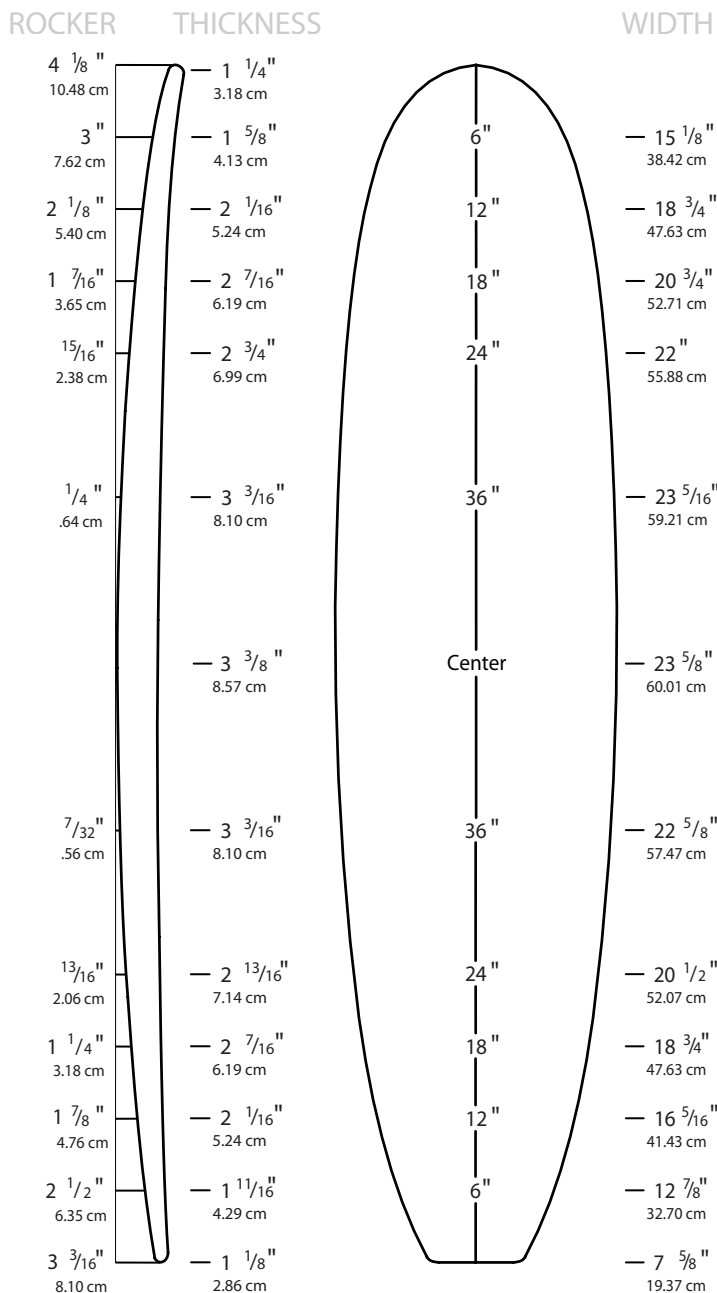

Overall Bottom Length: 8' 3 1/8" (251.78 cm)

Tip-to-tip Deck Length: 8' 2 5/8" (250.51 cm)

Maximum Width: 23 5/8" (60.01 cm)

Maximum Thickness: 3 3/8" (8.57 cm)

Displacement: 2.74 ft³ (77.6 L)

Introduced: July 2006

Available Rockers: Refer to **Rocker Catalog**

Shaper's Comments: Designed for retro fun-shapes. Based on feedback from 7'11"H and 8'4"H, improvements were made in the thickness and foil. Should accommodate many rockers and be an easy hand or machine shape blank.





Call (310) 225-6774 or visit www.usblanks.com

**84SP'X' ALSO AVAILABLE
+ 3/8" THICKER**

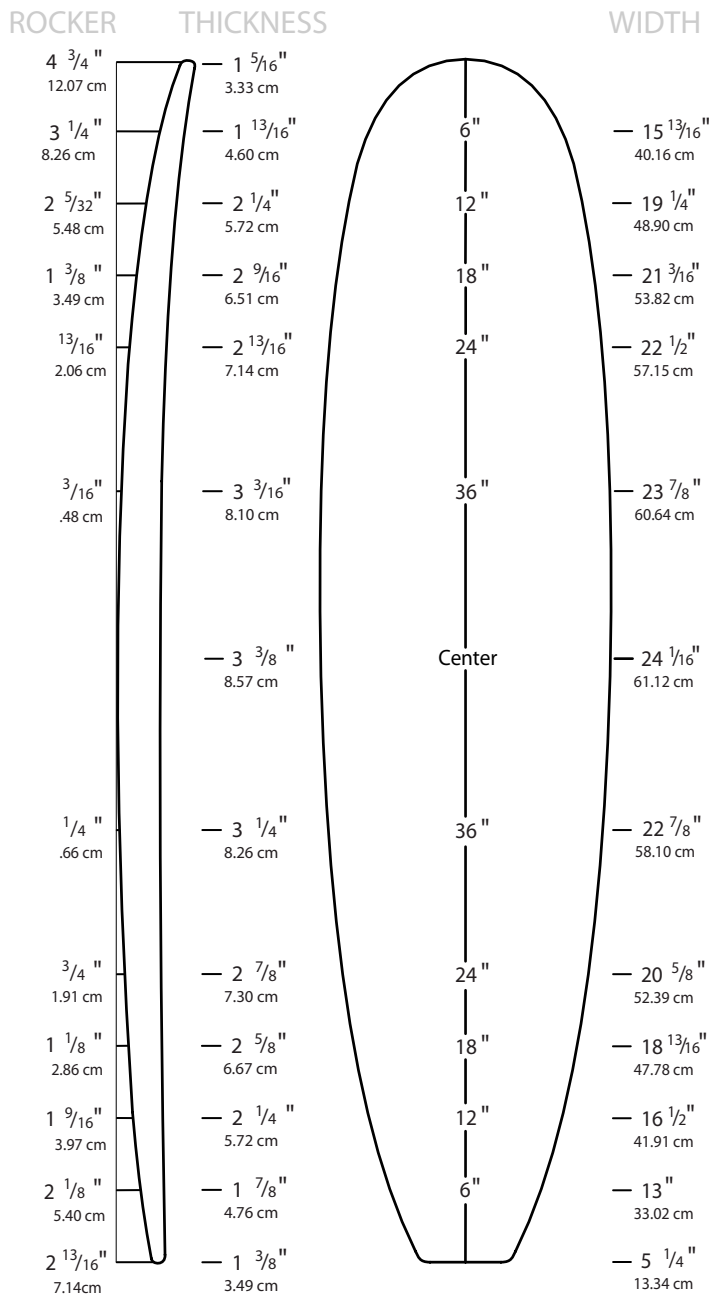

8'4"SP

Overall Bottom Length: 8' 4 7/16" (255.11 cm)

Tip-to-tip Deck Length: 8' 3 13/16" (253.52 cm)

Maximum Width: 24 3/16" (61.44 cm)

Maximum Thickness: 3 3/8" (8.57 cm)

"X" VERSION ALSO AVAILABLE

+3/8" THICKER

Displacement: 2.97 ft³ (84.0 L)

Introduced: May 2009

Available Rockers: Refer to [Rocker Catalog](#)

Shaper's Comments: This collaboration is the latest product of three decades of working together in one form or another. The 8'4SP was modeled after the Clark 8'3E with slightly more width in the nose for noserider style templates. Neutral tail rocker and improved curve in the bottom rocker from center to nose provide versatility for boards in the 8'0" to 8'4" size range.



Designed and shaped by: Charlie Smith & Tom Parrish



Call (310) 225-6774 or visit www.usblanks.com

8'5" A

Overall Bottom Length: 8' 6 ³/₈" (260.03 cm)

Tip-to-tip Deck Length: 8' 5 ¹/₂" (257.81 cm)

Maximum Width: 22" (55.88 cm)

Maximum Thickness: 3 ³/₈" (8.57 cm)

Displacement: 2.70 ft³ (76.5 L)

Introduced: September 2006

Available Rockers: Refer to **Rocker Catalog**

Shaper's Comments:

This newly made 8'5"A blank was lengthened to easily net an 8'6" bottom length. I redesigned the rail shape for less waste and stronger foam. I also widened the nose @ 12 by ¹/₂", and pumped up the max thickness to 3 ³/₈", to make it a more useful blank in this size/volume range. The new natural rocker in this mold design is the 8'5"A +¹/₂" nose, +³/₈" tail. This rocker being shaped in instead of glued up, will allow for a much more accurate finished rocker, due to no "spring back." I have the old 8'5"A natural rocker if anyone still wants it. All the "A" series of blanks are designed to take the majority of thickness of the bottom, leaving small adjustments in the nose and tail rocker and their thicknesses. This blank can be ordered wider or narrower as to allow for stronger decks/rails near the perimeter of the board outline, and less waste.

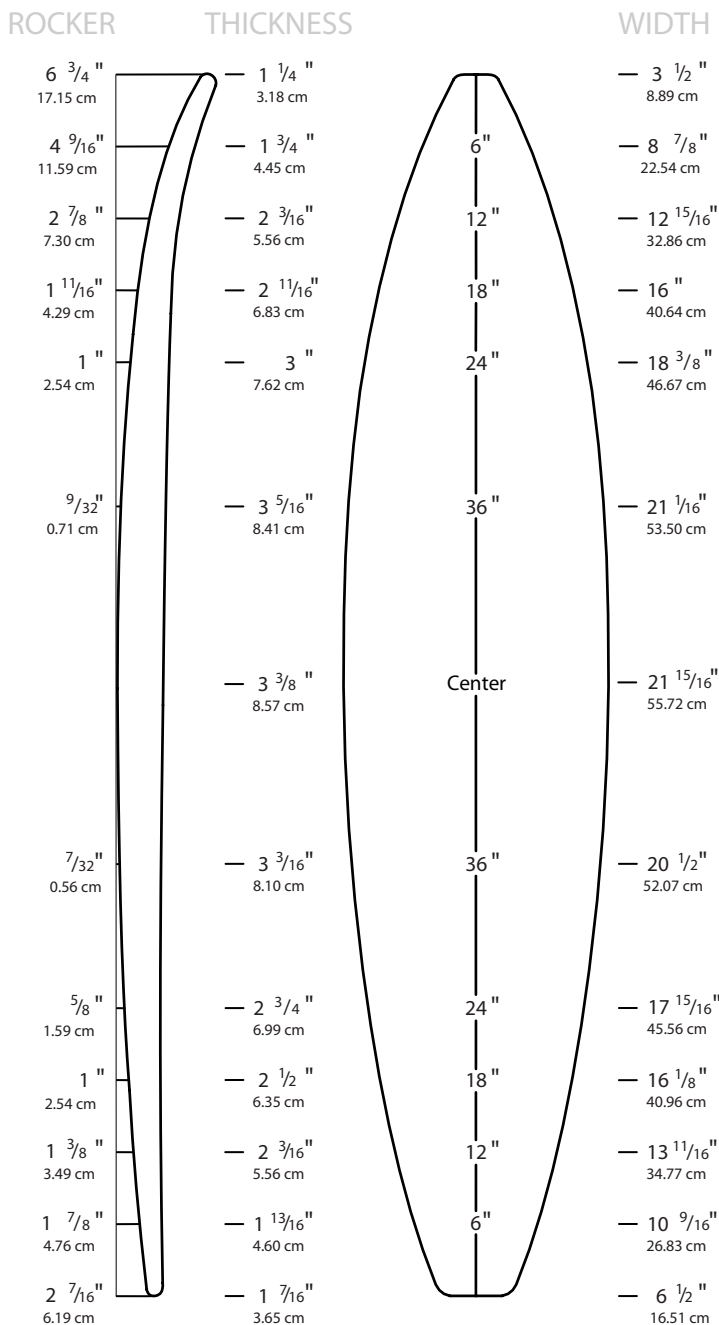

Designed and shaped by: **Pat Rawson**

Call (310) 225-6774 or visit www.usblanks.com

8'6" EA

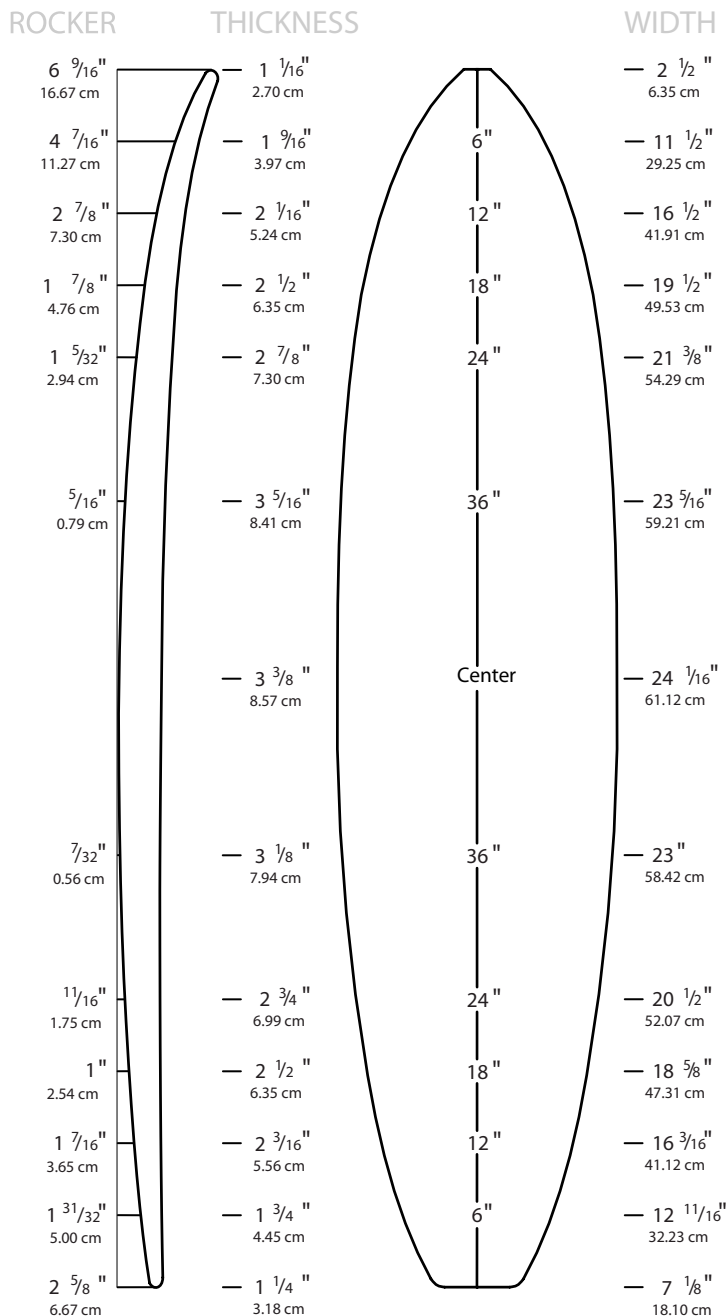

Overall Bottom Length: 8' 6" (259.08 cm)

Tip-to-tip Deck Length: 8' 5 1/8" (257.81 cm)

Maximum Width: 24 1/16" (61.12cm)

Maximum Thickness: 3 3/8" (8.57 cm)

Displacement: 2.72 ft³ (77.0 L)

Introduced: September 2006

Available Rockers: Refer to **Rocker Catalog**

Shaper's Comments: This blank is designed to yield big fun boards and big guy guns.



Call (310) 225-6774 or visit www.usblanks.com

8'9"Y

**89Y'X' ALSO AVAILABLE
+ 3/8" THICKER**

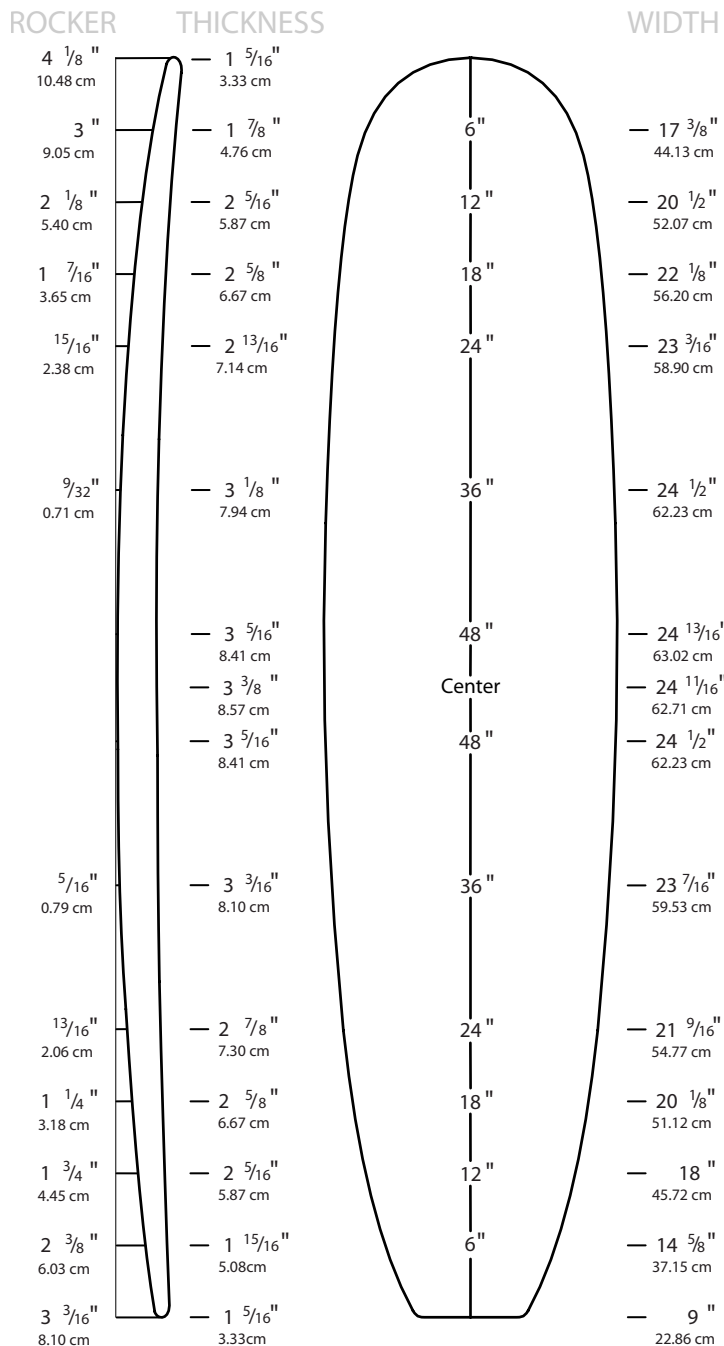

Overall Bottom Length: 8' 9" (266.70 cm)

Tip-to-tip Deck Length: 8' 8 1/2" (265.43 cm)

Maximum Width: 24 13/16" (63.02cm)

Maximum Thickness: 3 3/8" (8.57 cm)

"X" VERSION ALSO AVAILABLE

+3/8" THICKER

Displacement: 3.25 ft³ (92.1 L)

Introduced: April 2007

Available Rockers: Refer to [Rocker Catalog](#)

Shaper's Comments: Not much different than the 9'3Y, just less volume, 6" shorter, 1/4" narrower, 1/8" thinner and a little wider in the tail area. Good for 8'6" long boards.



Call (310) 225-6774 or visit www.usblanks.com

9'2" A

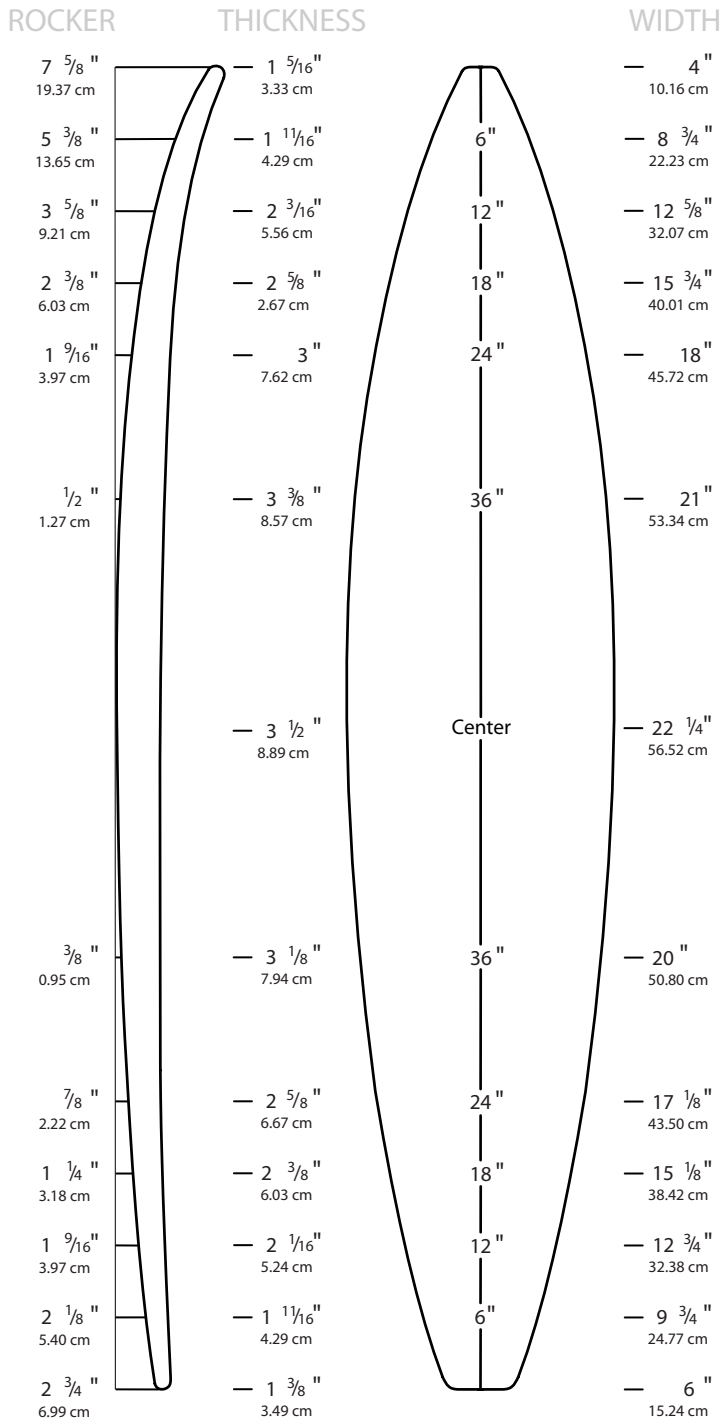

Overall Bottom Length: 9' 3" (281.94 cm)

Tip-to-tip Deck Length: 9' 2" (279.40 cm)

Maximum Width: 22 1/4" (56.52 cm)

Maximum Thickness: 3 1/2" (8.89 cm)

Displacement: 3.12 ft³ (88.3 L)

Introduced: September 2006

Available Rockers: Refer to [Rocker Catalog](#)

Shaper's Comments:

This newly made 9'2" A blank was lengthened to easily net a 9'2" bottom length. I redesigned the rail shape for less waste and stronger foam, and I also widened the nose @ 12" by 1/2", the wide point by 5/8", and the tail @ 12" by 1/2", as to be a more useful blank in this size/volume range. The new natural rocker in this mold design is the original 9'1" A +3/8" nose, +1/2" tail. This rocker being shaped in instead of glued up, will allow for a much more accurate finished rocker, due to no "spring back." We have the original 9'1" A natural rocker if anyone still wants it. All the "A" series blanks are designed to take the majority of thickness of the bottom, leaving small adjustments in the nose and tail rocker and their thicknesses. This blank can be ordered wider or narrower as to allow for stronger decks/rails near the perimeter of the board outline, and less waste.





Call (310) 225-6774 or visit www.usblanks.com

**93A'X' ALSO AVAILABLE
+ 3/8" THICKER**

9'3" A

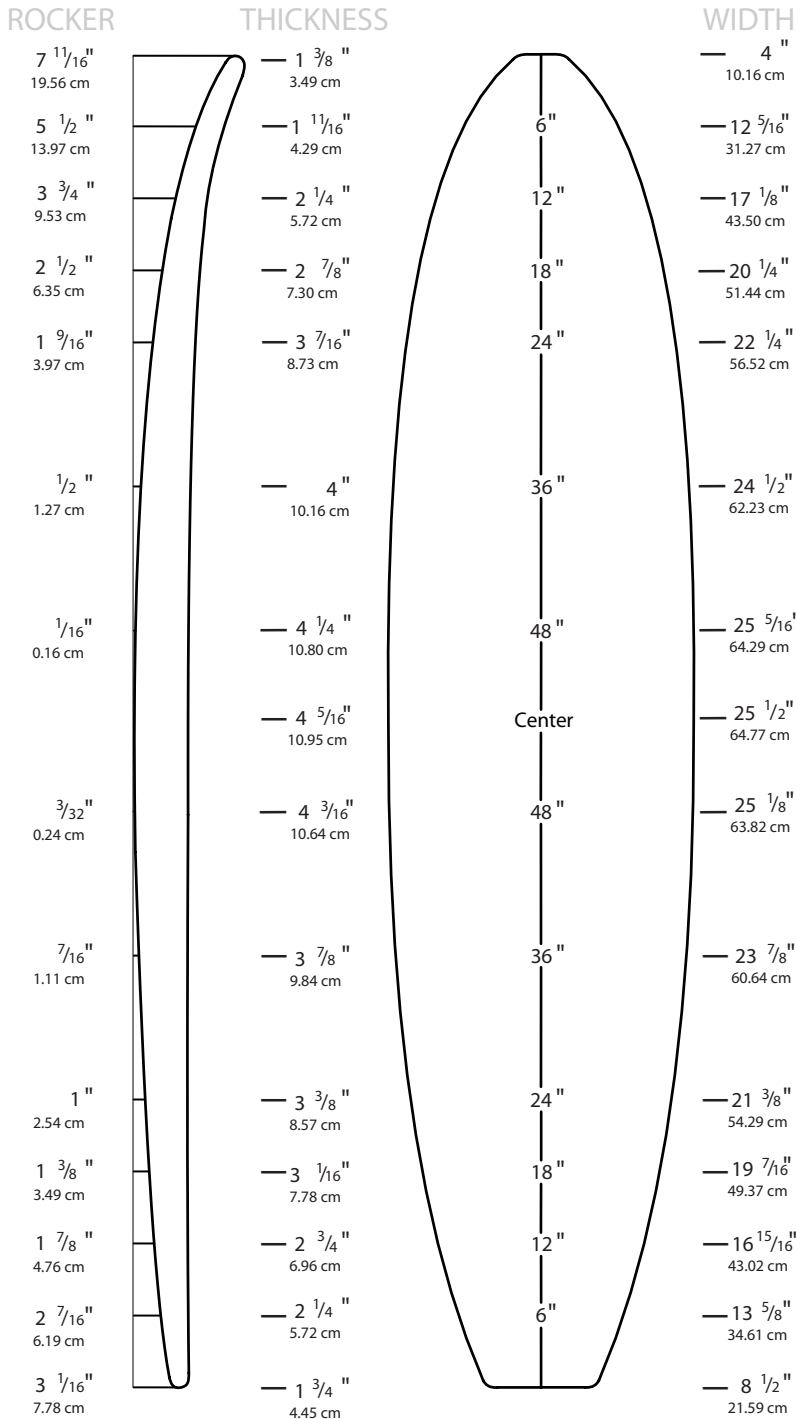

Overall Bottom Length: 9' 3 9/16" (283.37 cm)

Tip-to-tip Deck Length: 9' 2 5/8" (280.99 cm)

Maximum Width: 25 1/2" (64.77 cm)

Maximum Thickness: 4 5/16" (10.95 cm)

"X" VERSION ALSO AVAILABLE

+3/8" THICKER

Displacement: 4.30 ft³ (121.7 L)

Introduced: July 2008

Available Rockers: Refer to **Rocker Catalog**

Shaper's Comments: I designed the 9'3A to be a very serious "big guy" longer version of the 8'2A blank for either high performance, retro's or fun gun styles. Designed with a performance bottom curve and enough volume for 375 lb. surfers. It should be able to yield 9'0 x 24.5 x 4 also with ability to position the overall rocker and nose widths as needed. Cutting 2" of length off the nose will enable an 18 3/4" nose width at 12" back, and facilitate well for big guy fish designs. **MY SPECIAL THANKS TO BEN AIPA** who provided inspiration on the overall design of this blank and the new 8'2A.



Designed and shaped by: **Pat Rawson**

Call (310) 225-6774 or visit www.usblanks.com

9'3"Y

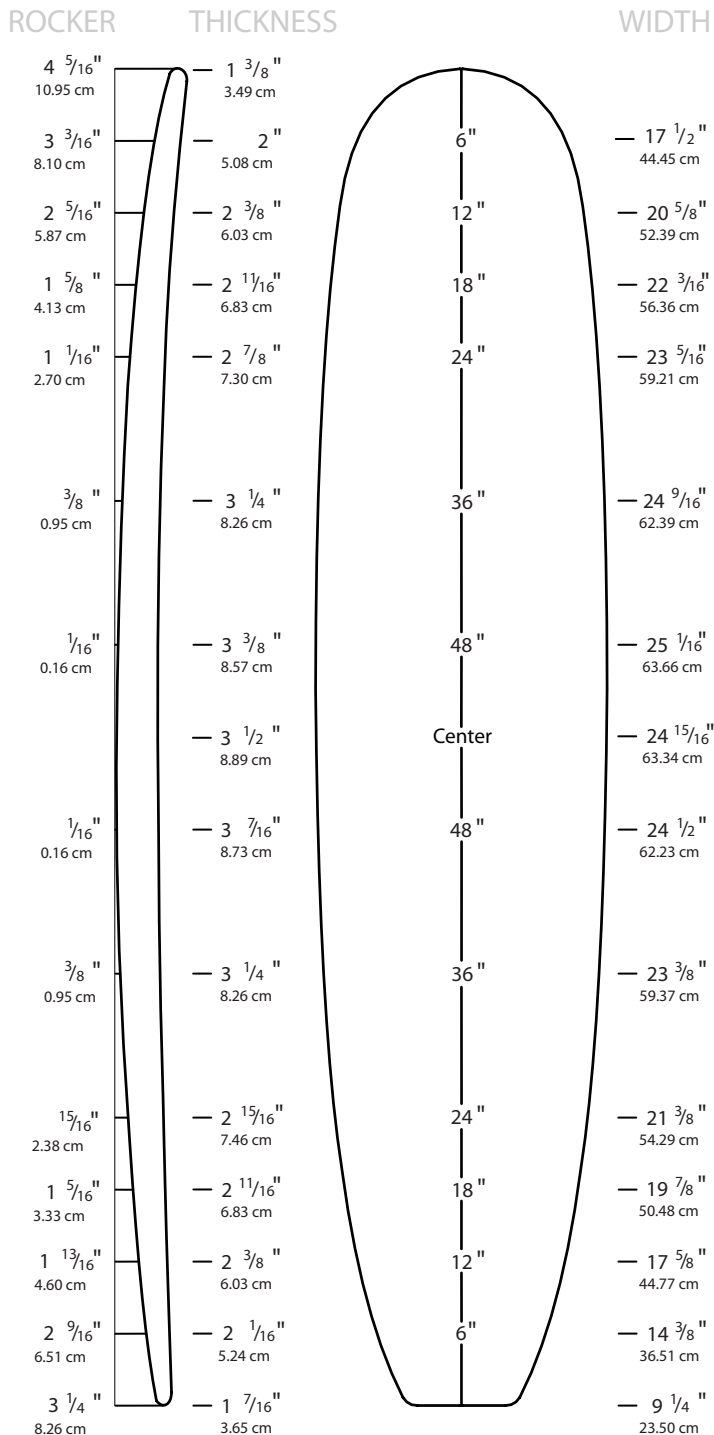

Overall Bottom Length: 9' 3" (281.94 cm)

Tip-to-tip Deck Length: 9' 2 5/8" (280.99cm)

Maximum Width: 25 1/16" (63.66 cm)

Maximum Thickness: 3 1/2" (8.89 cm)

Displacement: 3.70 ft³ (104.7 L)

Introduced: July 2006

Available Rockers: Refer to **Rocker Catalog**

Shaper's Comments: The original 10'1"Y was returned to me and I cleaned it up and the best side was scanned. That program has been used to machine cut the 9'3"Y, 9'8"Y, and the 10'8"Y plugs. The natural rocker is about in the middle of the demand curve. But remember, the further you change the natural rocker curve the wider the wood stringer it needed to hold it from spring back.



Call (310) 225-6774 or visit www.usblanks.com

9'4" B

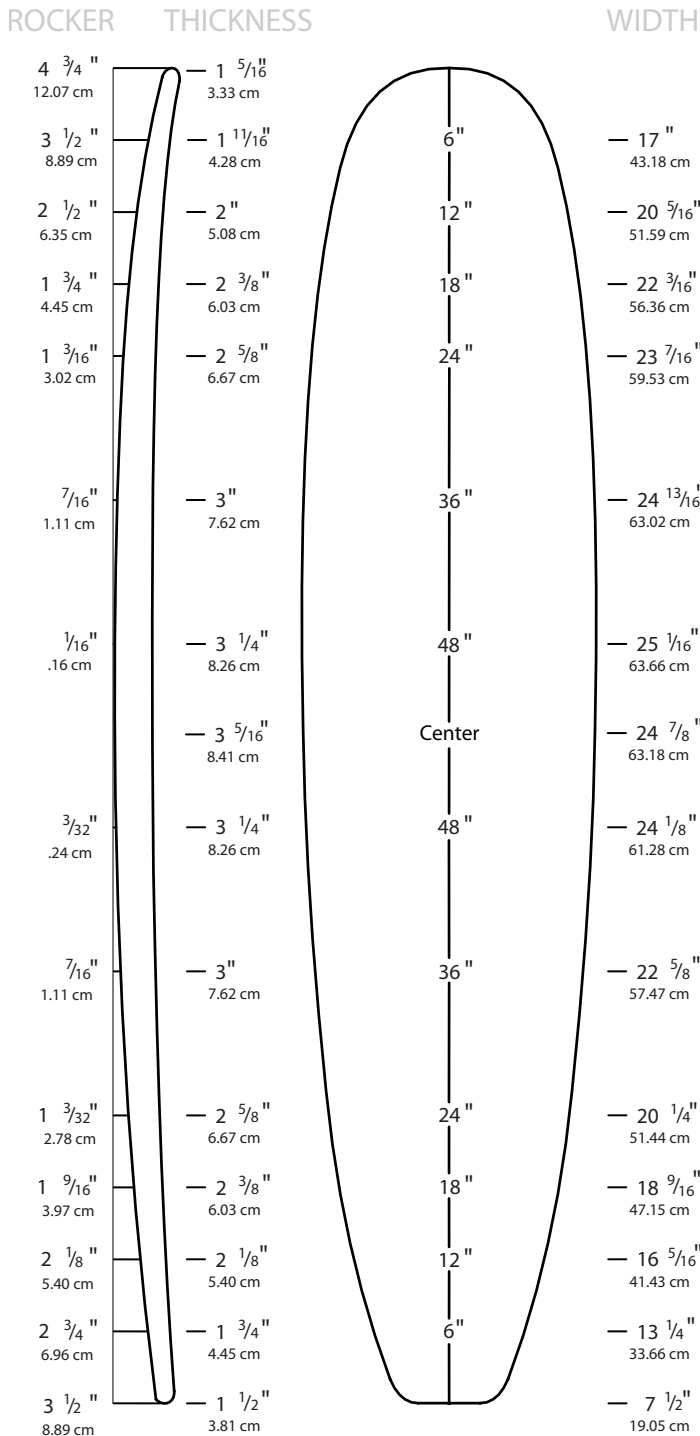

Overall Bottom Length: 9' 3 1/2" (283.21 cm)

Tip-to-tip Deck Length: 9' 3 1/16" (282.10 cm)

Maximum Width: 25 1/16" (63.66 cm)

Maximum Thickness: 3 5/16" (8.41 cm)

Displacement: 3.42 ft³ (96.7 L)

Introduced: July 2006

Available Rockers: Refer to [Rocker Catalog](#)

Shaper's Comments: From the original 9'4" B plug, with thickness added to the tail area of the deck to make it a more shaper friendly blank, close tolerance for strength, will net 24" x 3 1/8". Bottom rockers from the previous 9'4" B will work well with this blank.



Call (310) 225-6774 or visit www.usblanks.com

9'5" M

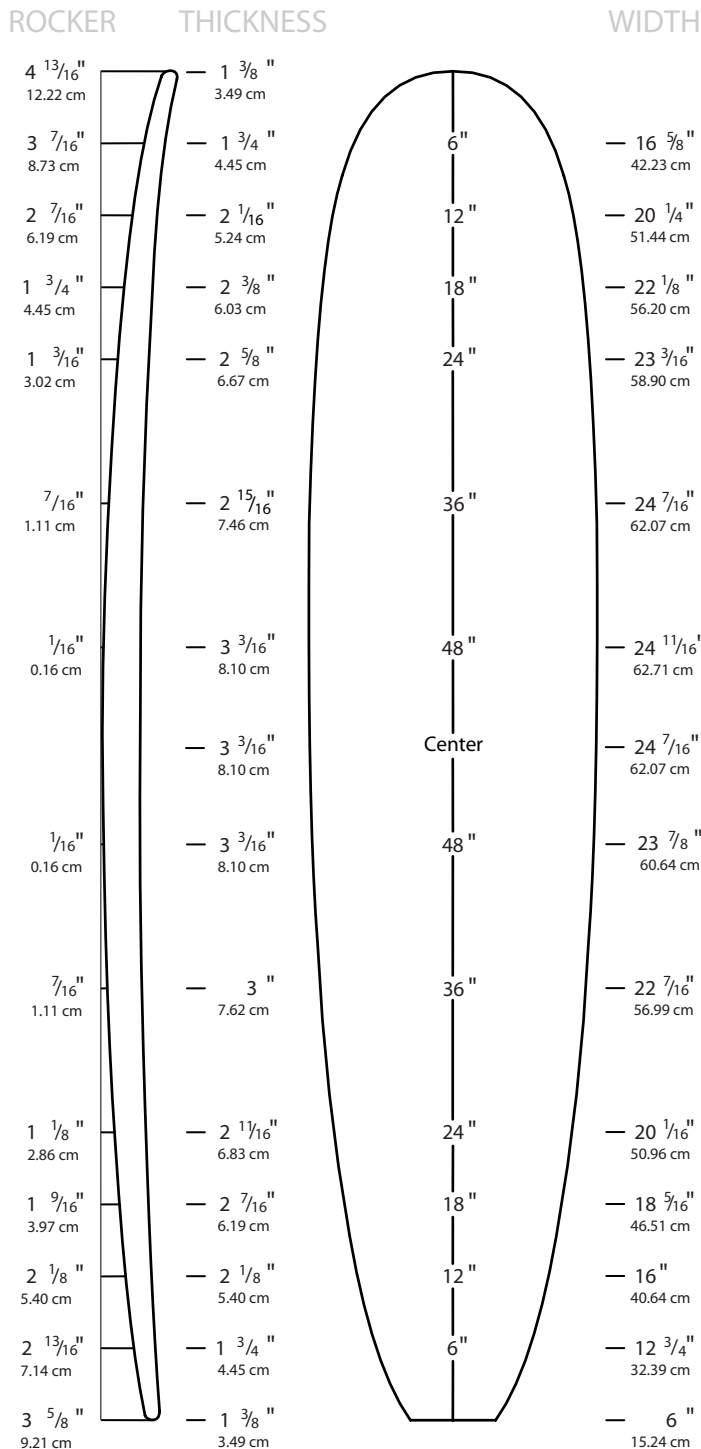

Overall Bottom Length: 9' 4 7/16" (285.59 cm)

Tip-to-tip Deck Length: 9' 3 3/4" (283.85 cm)

Maximum Width: 24 11/16" (62.71 cm)

Maximum Thickness: 3 3/16" (8.10 cm)

Displacement: 3.27 ft³ (92.7 L)

Introduced: August 2007

Available Rockers: Refer to **Rocker Catalog**

Shaper's Comments: This is a versatile high performance longboard blank designed to accommodate both machine and hand shaping. The deck is moderately flat with a slight taper out toward the tail to ensure maximum strength. It has slightly more volume in the nose and tail to allow more rocker to be shaped in if desired.



Call (310) 225-6774 or visit www.usblanks.com

9'8"Y

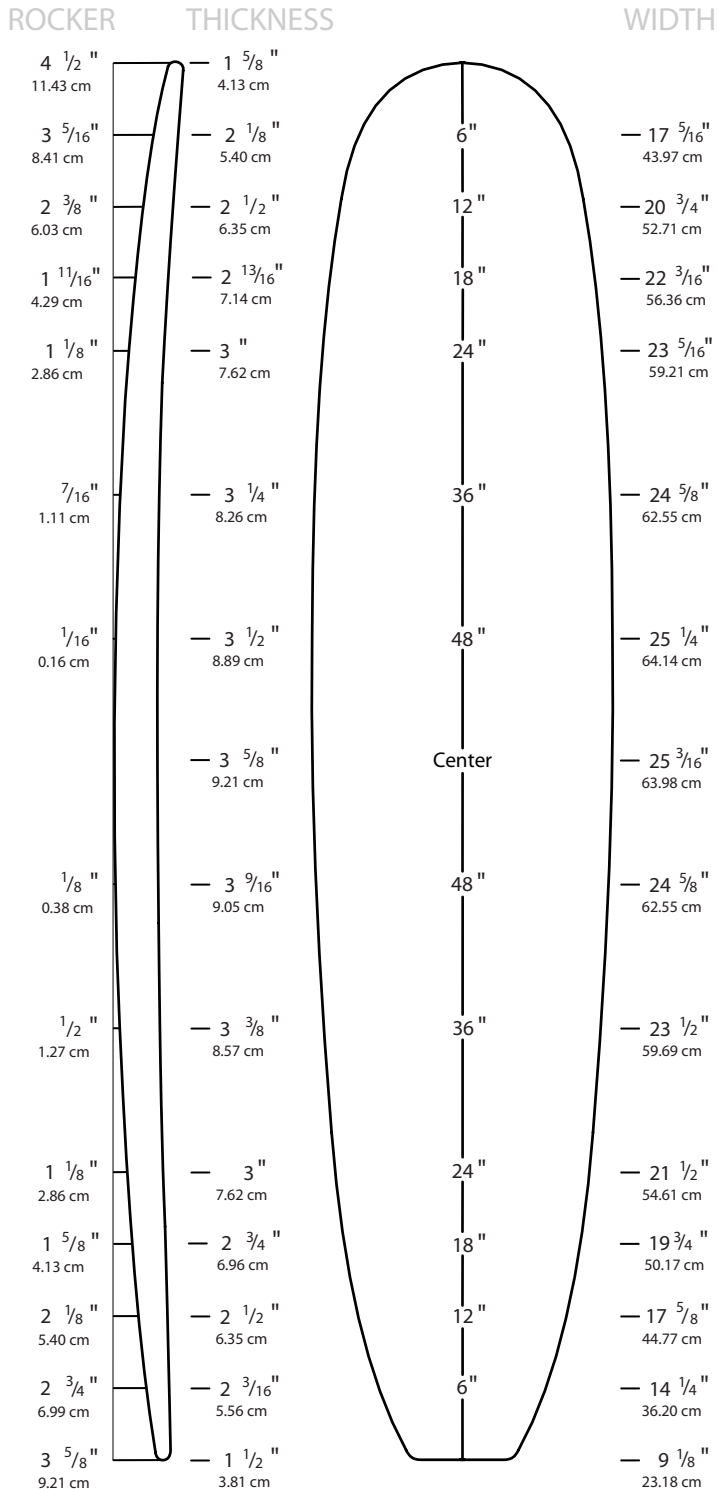

Overall Bottom Length: 9' 8 1/8" (294.96 cm)

Tip-to-tip Deck Length: 9' 7 3/4" (294.01 cm)

Maximum Width: 25 1/4" (64.14 cm)

Maximum Thickness: 3 5/8" (9.21 cm)

Displacement: 4.19 ft³ (118.7 L)

Introduced: July 2006

Available Rockers: Refer to **Rocker Catalog**

Shaper's Comments: The original 10'1"Y was returned to me and I cleaned it up and the best side was scanned. That program has been used to machine cut the 9'3"Y, 9'8"Y, and the 10'8"Y plugs. The natural rocker is about in the middle of the demand curve. But remember, the further you change the natural rocker curve the wider the wood stringer it needed to hold it from spring back.



Call (310) 225-6774 or visit www.usblanks.com

99A'X' ALSO AVAILABLE +3/8" THICKER

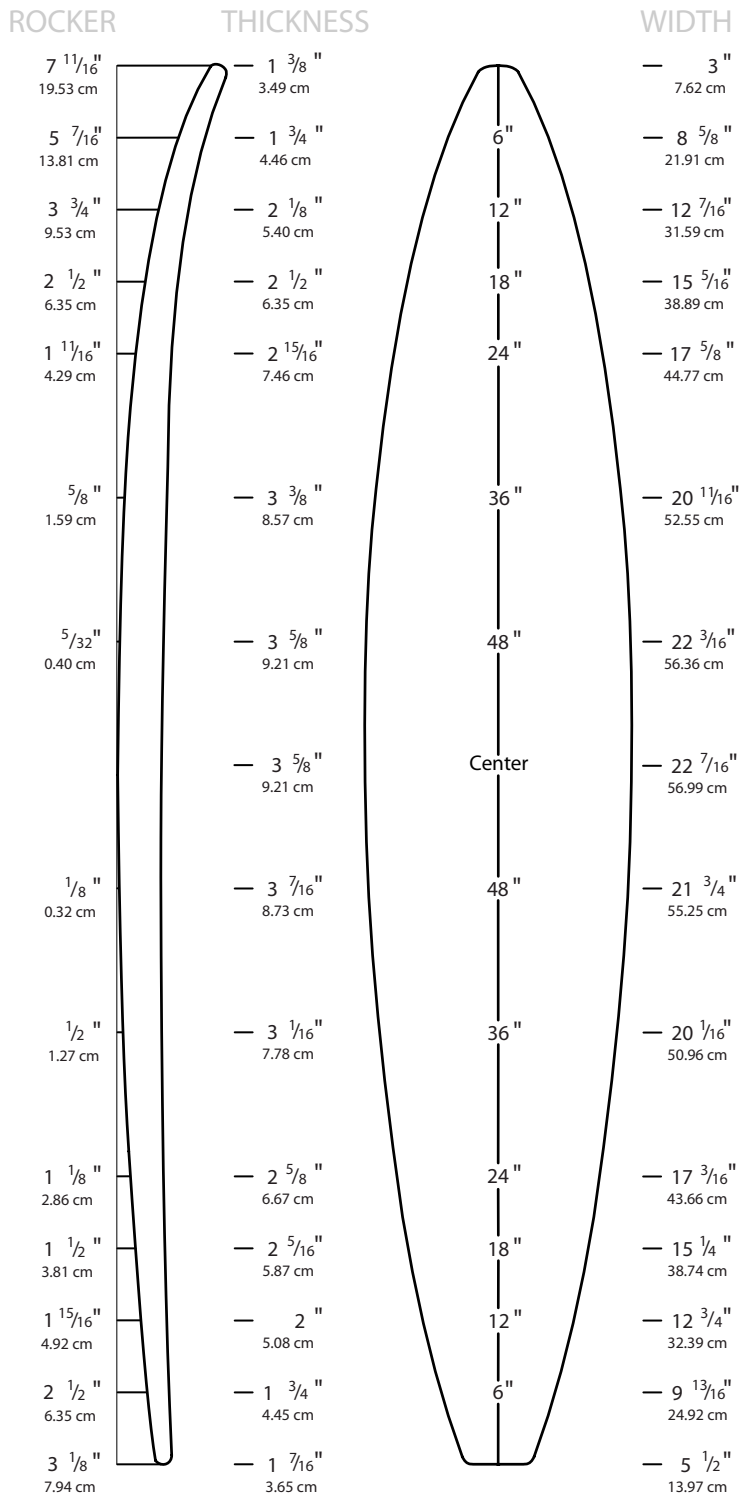

9'9" A

Overall Bottom Length: 9' 9 1/4" (297.82 cm)

Tip-to-tip Deck Length: 9' 8 3/8" (295.59 cm)

Maximum Width: 22 7/16" (56.99 cm)

Maximum Thickness: 3 11/16" (9.37 cm)

"X" VERSION ALSO AVAILABLE

+3/8" THICKER

Displacement: 3.23 ft³ (91.5 L)

Introduced: September 2006

Available Rockers: Refer to [Rocker Catalog](#)

Shaper's Comments:

This newly made 9'9"A blank was lengthened to easily net a 9'9" bottom length. I redesigned the rail shape for less waste and stronger foam, and I also widened the nose @12" by 1/2", the wide point by 1/4", and the tail @12" by 1/2" as to be a more useful blank in this size/volume range. The new natural rocker in this mold design is the 9'9"A +3/8" nose, +1/2" tail. This rocker being shaped in instead of glued up, will allow for a much more accurate finished rocker, due to no "spring back." I have the old 9'9"A natural rocker if anyone still wants it. All the "A" series blanks are designed to take the majority of thickness off the bottom, leaving small adjustments in the nose and tail rocker and their thicknesses. This blank can be ordered wider or narrower as to allow for stronger decks/rails near the perimeter of the board outline, and less waste.



Call (310) 225-6774 or visit www.usblanks.com

9'9" B

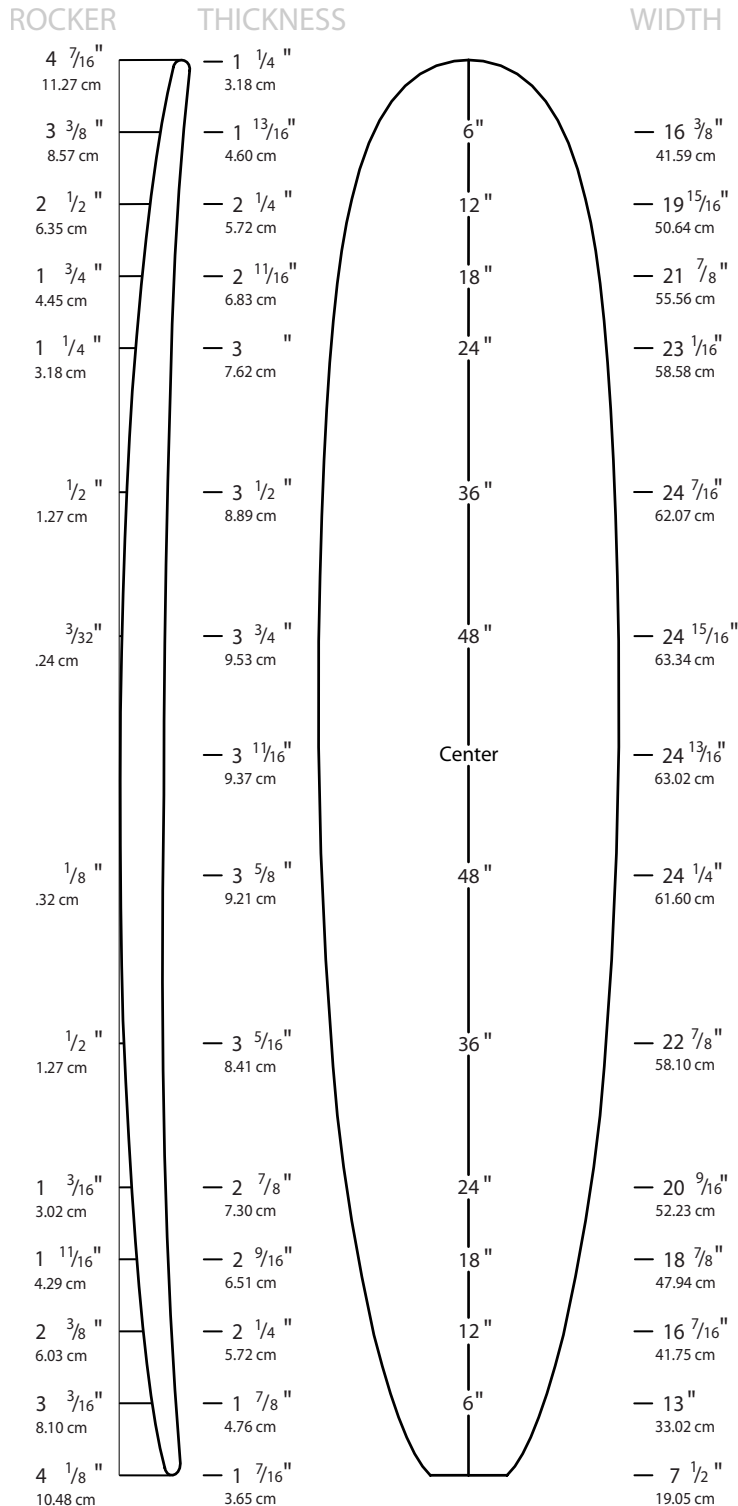

Overall Bottom Length: 9' 9 ⁵/₈" (298.77 cm)

Tip-to-tip Deck Length: 9' 9 ¹/₈" (297.50cm)

Maximum Width: 24 ¹⁵/₁₆" (63.34 cm)

Maximum Thickness: 3 ³/₄" (9.53 cm)

Displacement: 4.022 ft³ (113.9 L)

Introduced: July 2006

Available Rockers: Refer to **Rocker Catalog**

Shaper's Comments: Intended for longboard shapes from 9'2" to 9'6", this is a close tolerance blank that will net 24" x 3 ¹/₄" maximum dimensions. Natural rocker will make a nice all-around longboard shape. Rockers from the previous 9'8" will work well with this blank.



102B'X' ALSO AVAILABLE +1/4" THICKER

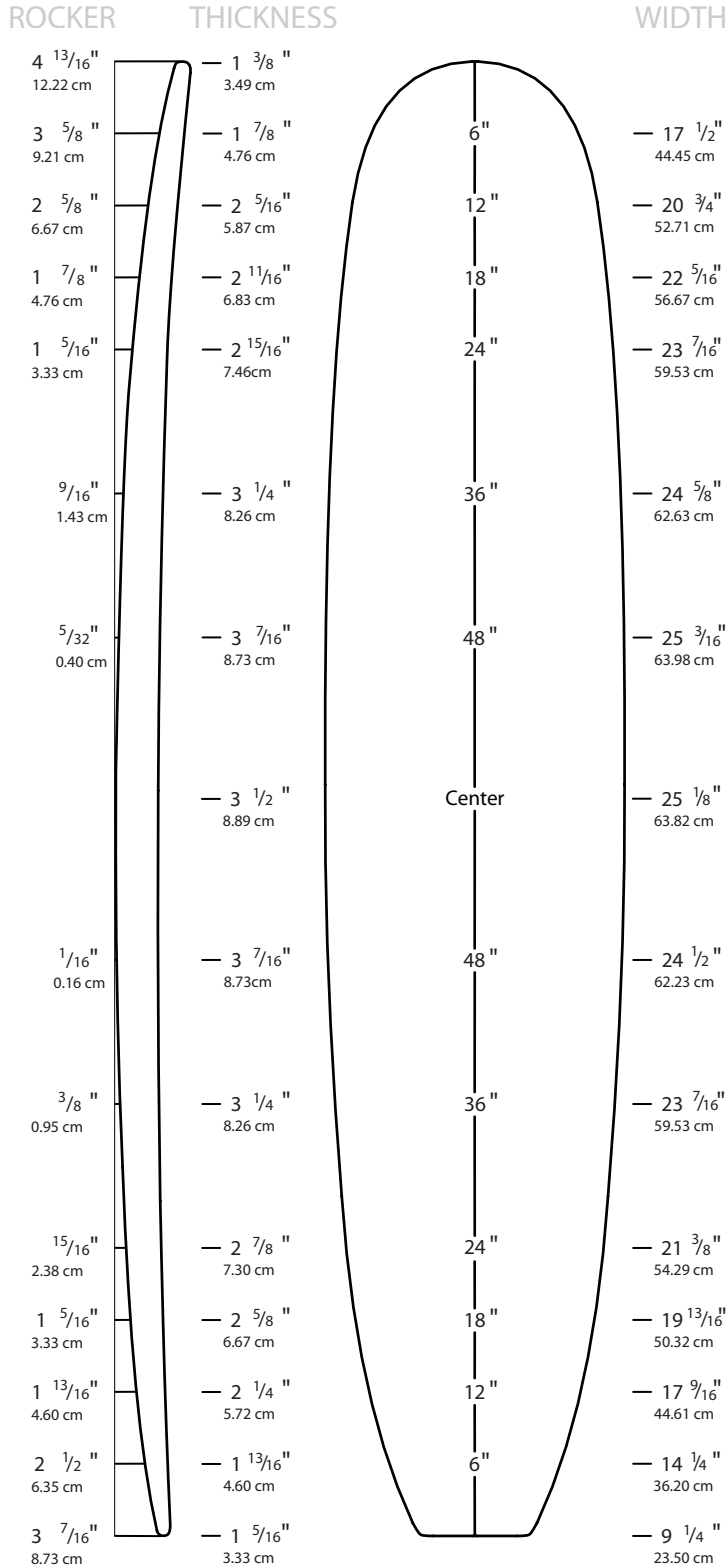

Overall Bottom Length: 10' 2 1/4" (310.52 cm)

Tip-to-tip Deck Length: 10' 1 1/2" (308.61 cm)

Maximum Width: 25 3/16" (63.98 cm)

Maximum Thickness: 3 1/2" (8.89 cm)

"X" VERSION ALSO AVAILABLE

+1/4" THICKER

Displacement: 4.26 ft³ (120.6 L)

Introduced: July 2006

Available Rockers: Refer to [Rocker Catalog](#)

Shaper's Comments: Intended for longboard shapes from 9'8" to 10'0", this is a close tolerance blank to net 24" x 3 3/8" maximum dimensions. Rockers from the previous 10'1" will work well with this blank. 10'1"Y natural rocker is available for this blank.



106A'X' ALSO AVAILABLE +1/2" THICKER

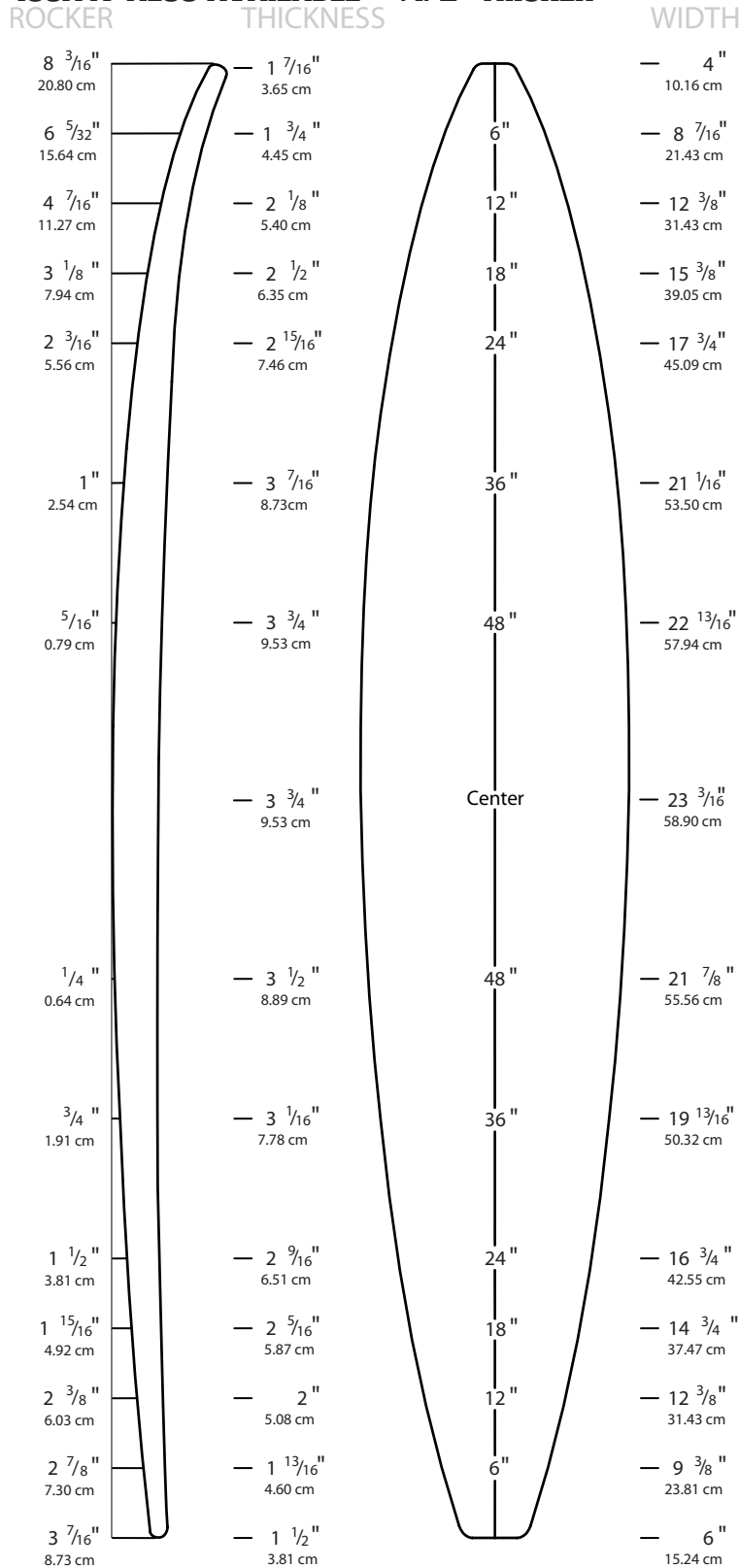

Overall Bottom Length: 10' 6 3/4" (321.95 cm)
Tip-to-tip Deck Length: 10' 5 7/8" (319.72 cm)
Maximum Width: 23 3/16" (58.90 cm)
Maximum Thickness: 3 3/4" (9.53 cm)

"X" VERSION ALSO AVAILABLE +1/2" THICKER

Displacement: 3.77 ft³ (106.8 L)
Introduced: September 2006
Available Rockers: Refer to **Rocker Catalog**
Shaper's Comments:

This newly made 10'6" A blank was lengthened to easily net a 10'6" bottom length. Using parts of the old 10'6" as a start, I kept the rail shape the same for less waste and stronger foam, and widened the point by 3/8". The new natural rocker in this mold design is the 10'6" A +5/8" nose, +3/4" tail. This rocker being shaped in instead of glued up, will allow for a much more accurate finished rocker, due to no "spring back." I have the old 10'6" natural rocker if anyone still wants it. All the "A" series of blanks are designed to take the majority of thickness off the bottom, leaving small adjustments in the nose and tail rocker and their thicknesses. This blank can be ordered wider or narrower as to allow for stronger decks/rails near the perimeter of the board outline, and less waste.



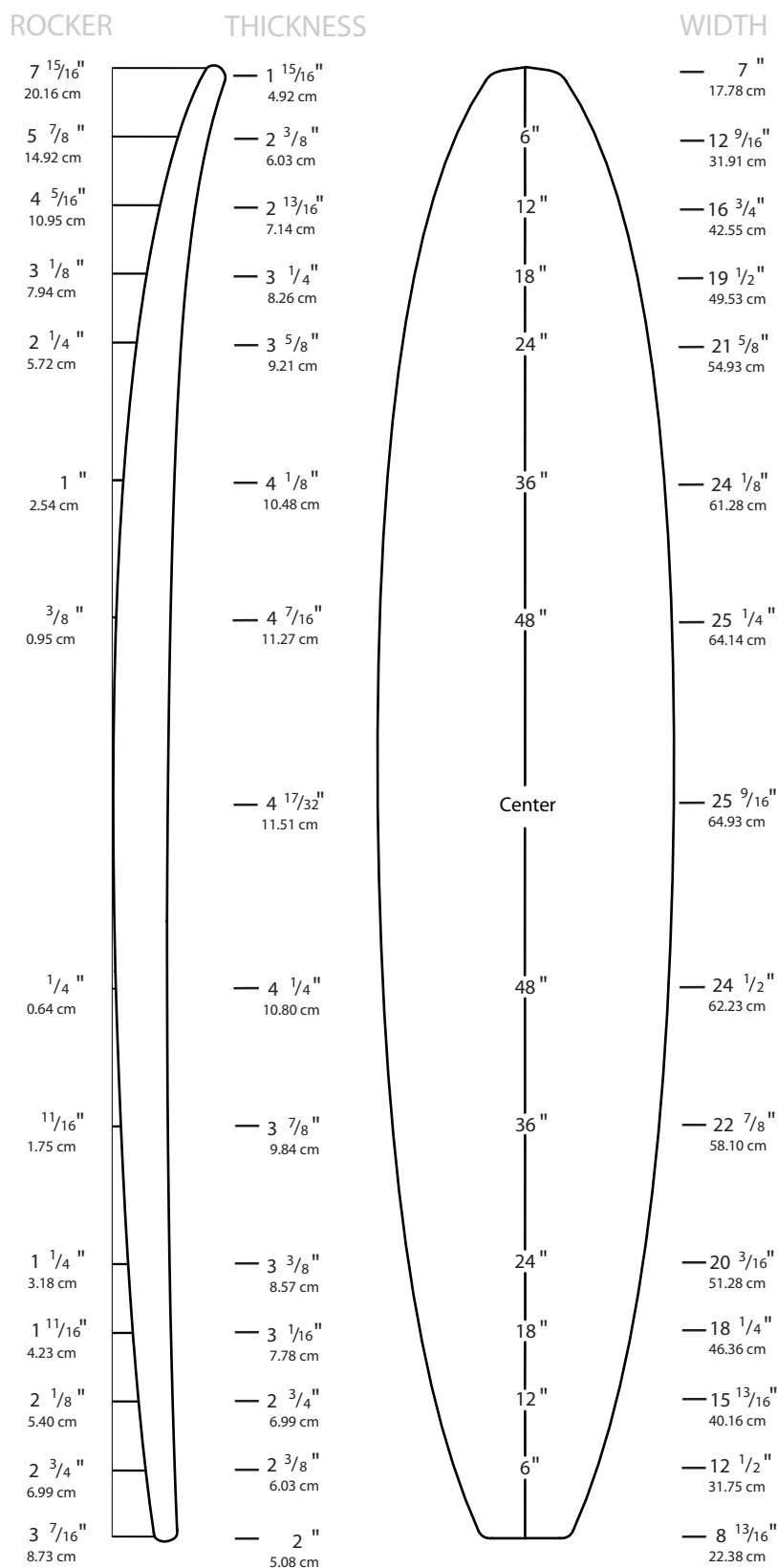

Overall Bottom Length: 10' 9 1/2" (328.93 cm)
Tip-to-tip Deck Length: 10' 8 1/4" (325.76 cm)
Maximum Width: 25 9/16" (64.93 cm)
Maximum Thickness: 4 9/16" (11.59 cm)
Displacement: 5.63 ft³ (159.3 L)
Introduced: November 2013
Rockers: Natural

Shaper's Comments: The 10'8 BG was designed and built by Eric Arakawa and Pat Rawson using a combined effort. "The original plan was to build a combo Big Guy/Gun blank (ala "BG") that could be offset-cut narrower for performance Guns, but have a built-in, wider stock width suitable for many different options. The 93A was used as a conceptual starting point, and the bottom and deck contours are fairly flat in the stringer area to enable ordering an offset cut to net a narrower version (23.5" to 24") without the normal peak at the stringer that more contoured blanks can produce when narrowing by 2" - 3". The rocker is universal and the natural rocker should offer many design opportunities, due to the ample thickness in the nose and tail areas."



Call (310) 225-6774 or visit www.usblanks.com

10'8"Y

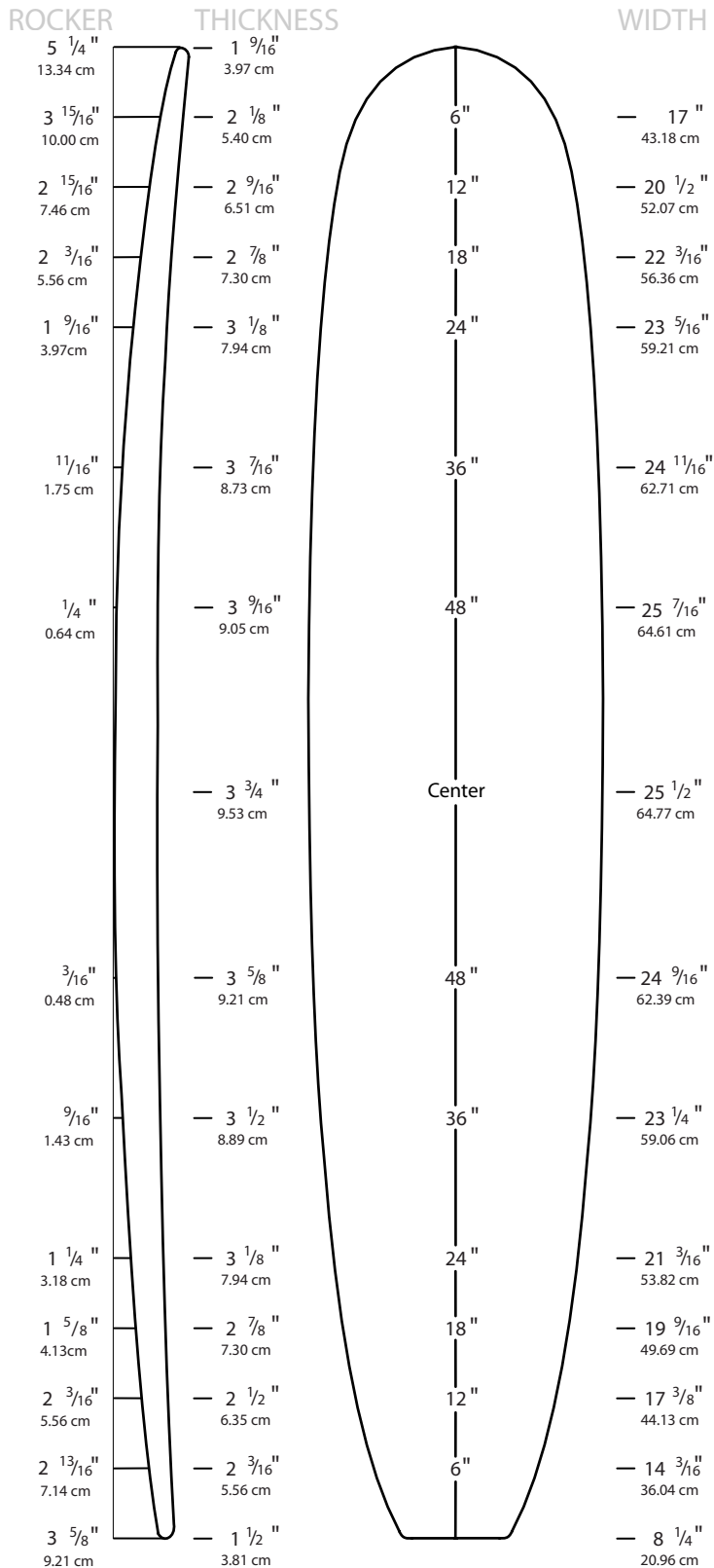

Overall Bottom Length: 10' 7 7/8" (324.80 cm)

Tip-to-tip Deck Length: 10' 7 5/16" (323.37 cm)

Maximum Width: 25 1/2" (64.77 cm)

Maximum Thickness: 3 3/4" (9.53 cm)

Displacement: 4.77 ft³ (135.2 L)

Introduced: September 2006

Available Rockers: Refer to **Rocker Catalog**

Shaper's Comments: The original 10'1"Y was returned to me and I cleaned it up and the best side was scanned. That program has been used to machine cut the 9'3"Y, 9'8"Y, and the 10'8"Y plugs. The natural rocker is about in the middle of the demand curve. But remember, the further you change the natural rocker curve the wider the wood stringer it needed to hold it from spring back.



Call (310) 225-6774 or visit www.usblanks.com

10'10" T

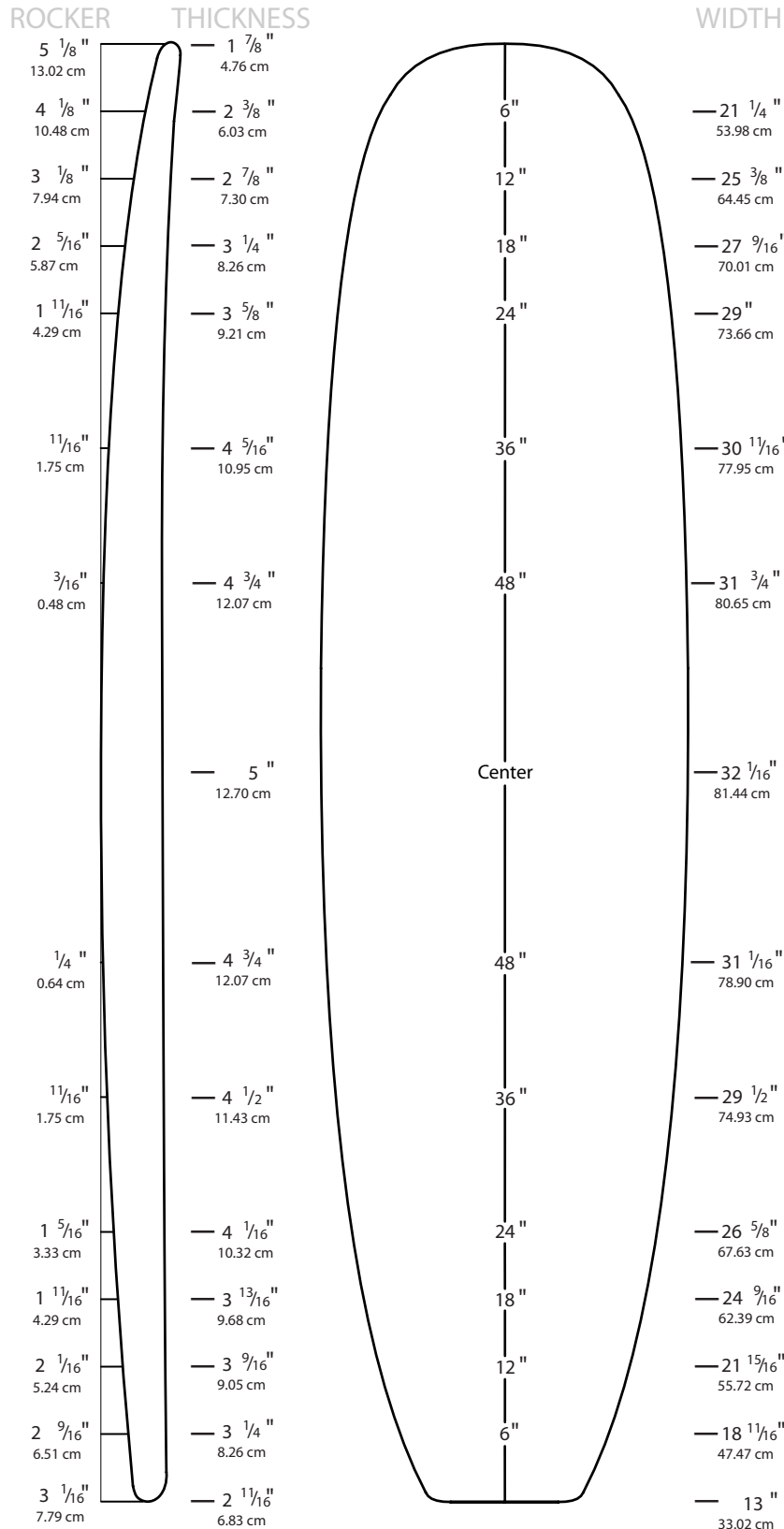

Overall Bottom Length: 10' 9 3/8" (328.61 cm)

Tip-to-tip Deck Length: 10' 9" (327.66 cm)

Maximum Width: 32 1/16" (81.44 cm)

Maximum Thickness: 5" (12.70 cm)

Displacement: 8.31 ft³ (235.3 L)

Introduced: August 2008

Available Rockers: Refer to **Rocker Catalog**

Shaper's Comments:

I tried to make this Stand Up blank as versatile as possible. It has plenty of width and thickness to do just about anything in a Stand Up Paddle surfboard. The rocker should also allow shapers a wide range of options.



11'3"D

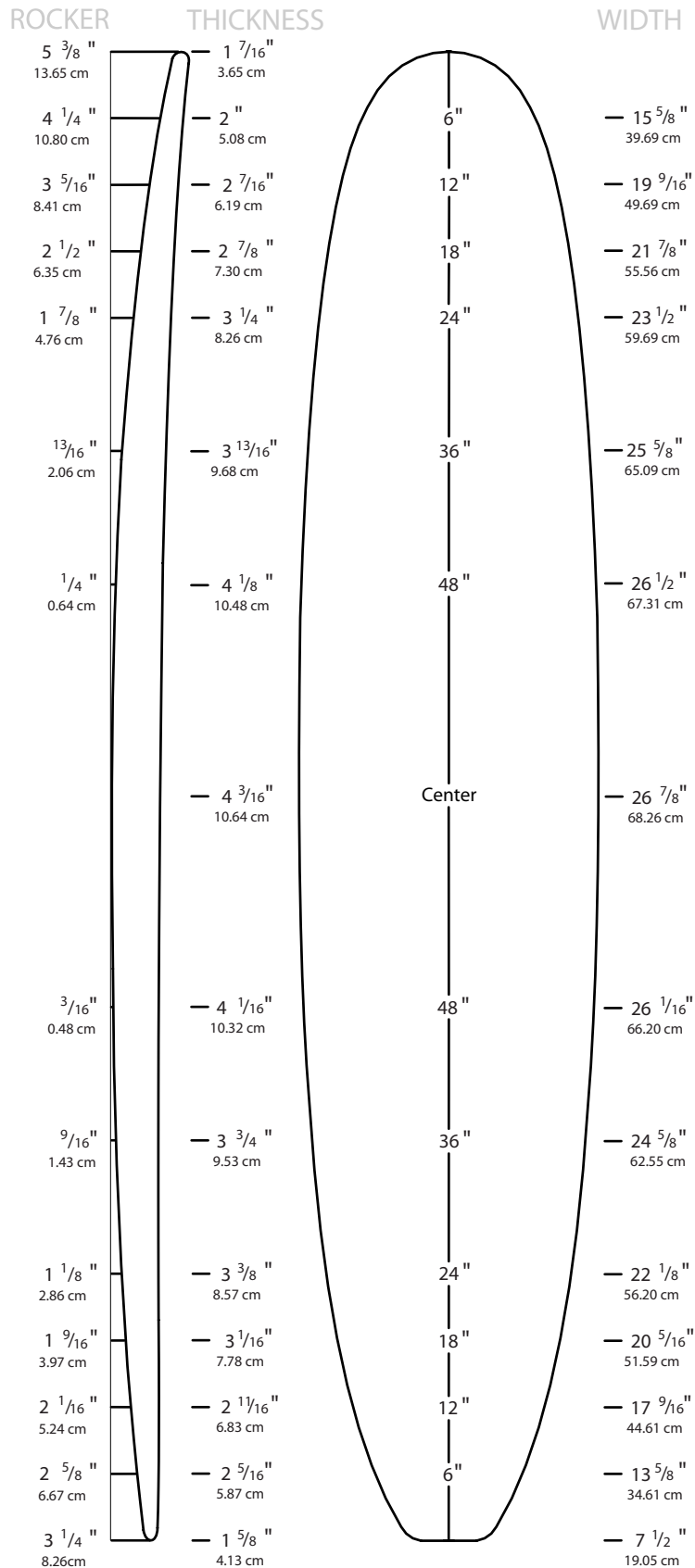

Overall Bottom Length: 11' 2 1/2" (341.63 cm)
Tip-to-tip Deck Length: 11' 2" (340.36 cm)
Maximum Width: 26 7/8" (68.26 cm)
Maximum Thickness: 4 7/32" (10.72 cm)
Displacement: 5.74 ft³ (162.7 L)
Introduced: January 1990. Has proved to be as versatile as outlined in comments. Good proportions for long guns.
Available Rockers: Refer to **Rocker Catalog**
Shaper's Comments: "Shaper's Delight" will yield an excellently proportioned 10'6". When finished, it will easily float persons up to 250 lbs. An excellent rental board. Nose rocker can be adjusted up to 6 1/2" or lowered to 4 1/2". Tail rocker can be adjusted up to 1" or down 1/2". Excellent family board. Perfect San Onofre board or for those crowded days at your favorite point break. Great for giving lessons. Perfect for noseriding. May be used for guns with rocker adjustment and width removed from center prior to gluing. Suggested minimum stringer thickness: 3/16".
Special note: All rockers for this blank will not fit on redwood or cedar.



11'8" BG

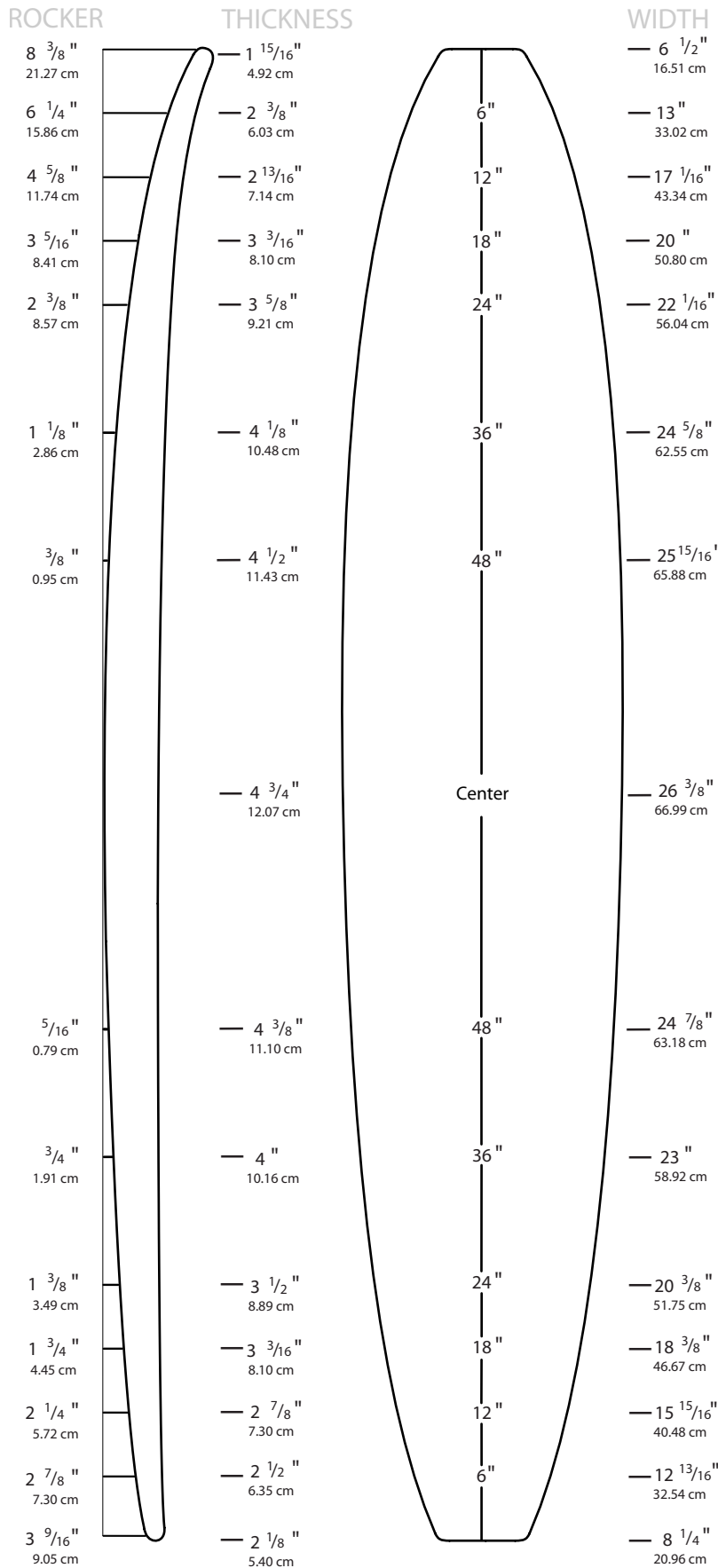

- Overall Bottom Length:** 11' 9 1/4" (358.78 cm)
- Tip-to-tip Deck Length:** 11' 8 5/16" (356.39cm)
- Maximum Width:** 26 3/8" (66.92 cm)
- Maximum Thickness:** 4 3/4" (12.07cm)
- Displacement:** 6.70 ft³ (189.7 L)
- Introduced:** January 2014
- Rockers:** Natural

Shaper's Comments: The 11'8 BG is the big brother to the 10'8 BG, and was desinged and built by Pat Rawson and Eric Arakawa using a combined effort. "The original plan was to build a combo Big Guy/Gun blank (ala "BG") that could be offset-cut narrower for performance Guns, but have a built-in, wider stock width suitable for many different options. The 93A was used as a conceptual starting point, and the bottom and deck contours are fairly flat in the stringer area to enable ordering an offset cut to net a narrower version (23.5" to 24") without the normal peak at the stringer that more contoured blanks can produce when narrowing by 2" - 3". The rocker is universal and the natural rocker should offer many design opportunities, due to the ample thickness in the nose and tail areas."

Designed and shaped by:
Pat Rawson & Eric Arakawa



Superfused EPS

After extensive research and development US Blanks is proud to announce the introduction of our **Superfused Molded EPS**. Our proprietary bead and revolutionary molding and production techniques have allowed us to develop a surfboard specific product that is superior to any other EPS foam on the market today. Our newly developed EPS technology allows us to achieve superior bead fusion, consistency and quality. Combined with our progressive new mold designs, we have taken epoxy board building to a whole new level.

What makes US Blanks Superfused EPS different? Unlike most other manufacturers our blanks are shape molded under extreme pressure. This allows for superior penetration and bead fusion during the molding process that cannot be achieved in block molding. Combined with our proprietary bead and industry leading production techniques, our process generates fusion characteristics that simply cannot be achieved through other methods. The tight fusion means the foam is considerably more air tight and water tight than any of its predecessors thus eliminating the need for taping or spackling before machining, or spackling / seal coating before glassing. As a result it glasses up lighter and stronger as it absorbs less resin but maintains a superior mechanical bond due to its incredible surface properties.

Our shape molded blanks result in less work for the shaper as our outlines, rockers, and crowned decks allow the craftsman to zero in on the finished shape much more quickly and easily. Our molding capabilities also allow us to produce each blank size in different thicknesses which means you can chose the blank that best suits your shape while cutting down on shaping time and waste.

Due to the incredible strength and memory characteristics of EPS foam many shapers have experienced “spring back” problems in the past when applying forced rocker adjustments to this particular type of foam. By not applying any post induced surface tensions we have eliminated these known “spring back” problems. We accomplish this by starting with an excellent rocker along with increased volume in the nose and tail areas allowing the shaper to accommodate proprietary custom rocker configurations without having to make physical adjustments during the glue up process.

Another extremely important aspect of shape molding is the fact that it cuts down on waste and all EPS scraps are 100% recyclable. Please do your part and check with your local city to see if they offer a recycling program which you can participate in.

Most of our sizes are offered in both 1.7 pcf and 2.0 pcf densities. Combined with our variable thickness capabilities, **US Blanks Superfused EPS** has quickly become the most user friendly, versatile, industry leading EPS on the market, and has set a new standard world wide.



6'5" EPS SUPERFUSED

Call (310) 225-6774 or visit www.usblanks.com

NEW MAX. THICKNESS 2-3/4"

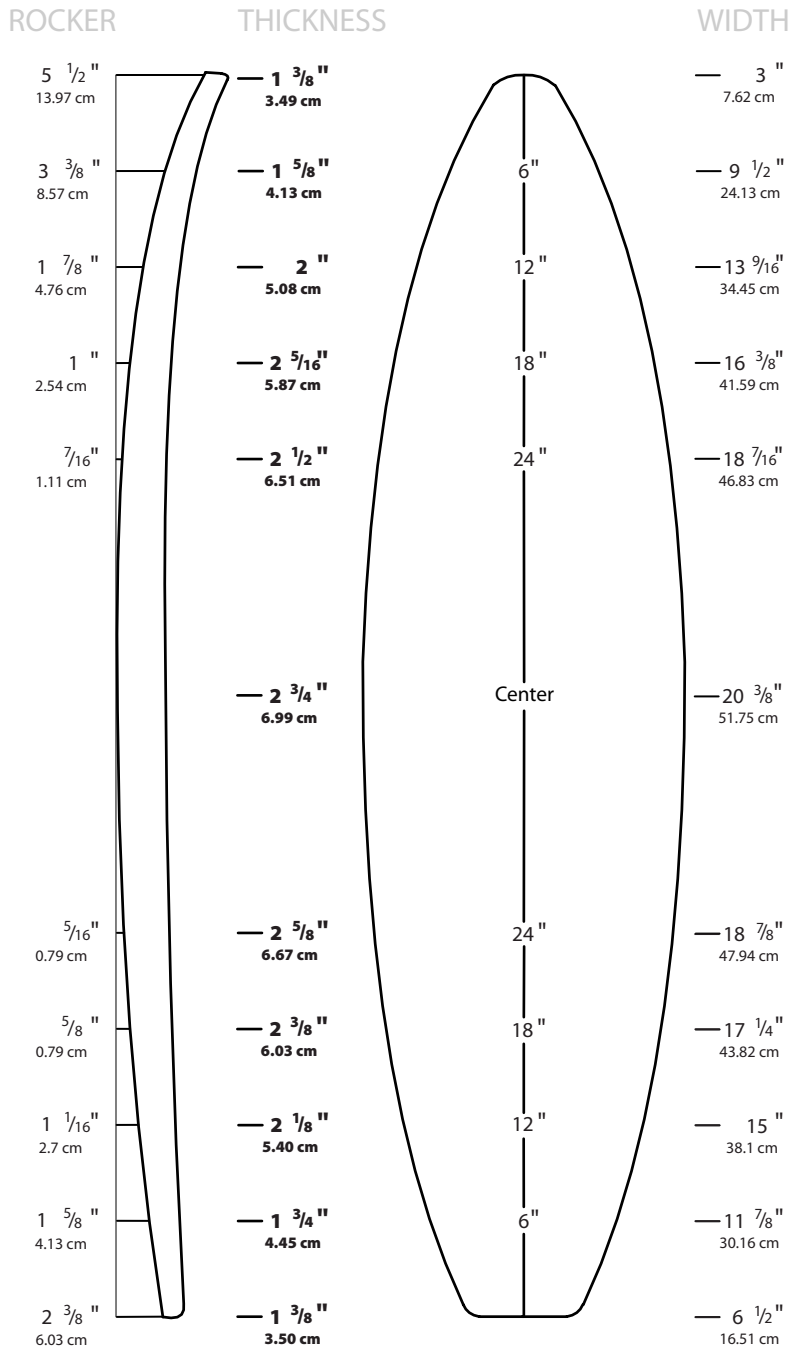

Overall Bottom Length: 6' 5 13/16" (197.64 cm)

Tip-to-tip Deck Length: 6' 4 13/16" (195.10 cm)

Maximum Width: 20 3/8" (51.75 cm)

Maximum Thickness: 2 3/4" (6.99 cm)

Displacement:

Introduced: October 2007

Rockers: Natural

Available Densities: 1.7 PCF and 2.0 PCF

Shaper's Comments: This blank is designed for high performance short boards up to 20-1/4" in width. At 2-3/4" thick it remains versatile and will accept subtle rocker adjustments from center.



Designed and shaped by: **Eric Arakawa**

Call (310) 225-6774 or visit www.usblanks.com

NEW "X" MODEL THICKNESS 3"

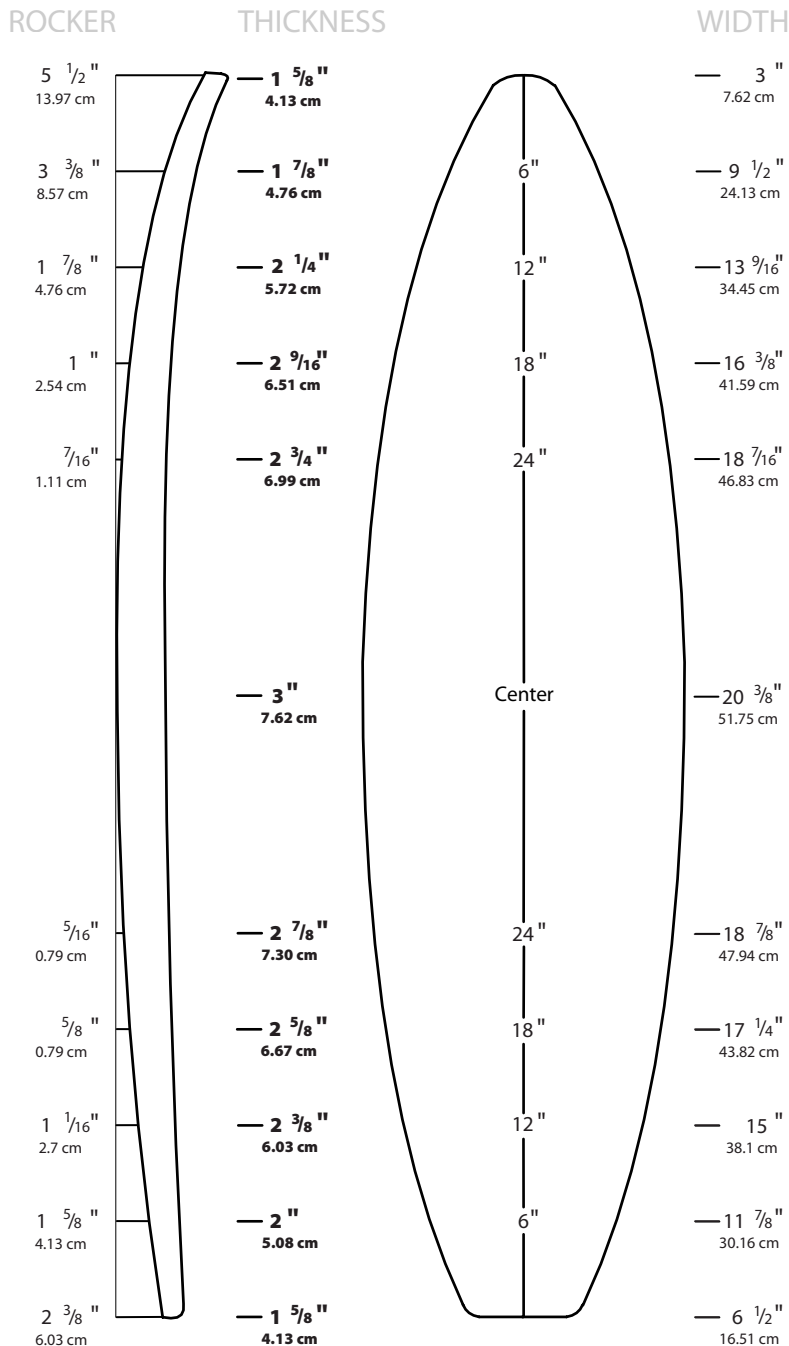

Overall Bottom Length: 6' 5 13/16" (197.64 cm)

Tip-to-tip Deck Length: 6' 4 13/16" (195.10 cm)

Maximum Width: 20 3/8" (51.75 cm)

Maximum Thickness: 3" (7.62 cm)

Displacement:

Introduced: October 2007

Rockers: Natural

Available Densities: 1.7 PCF and 2.0 PCF

Shaper's Comments: At 3" maximum thickness, this blank is identical to the previous version with 1/4" additional thickness along the entire length. Designed for high performance short boards up to 20-1/4" in width, and will also accommodate small Fish models due to the extra thickness. An ideal blank for machine shaping.



6'8" EPS SUPERFUSED

MAX. THICKNESS 2-7/8"

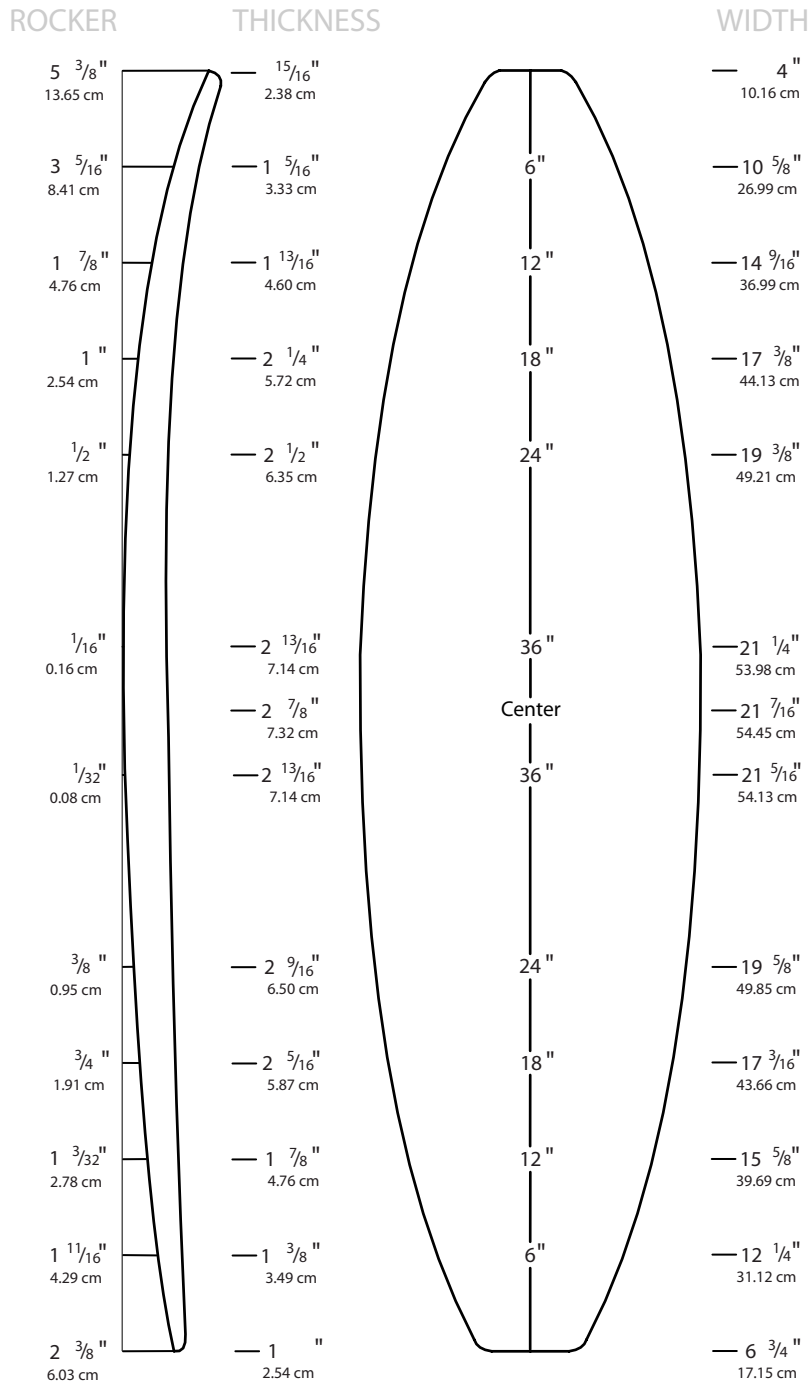

Overall Bottom Length: 6' 9" (205.74 cm)

Tip-to-tip Deck Length: 6' 8" (203.20 cm)

Maximum Width: 21 7/16" (54.45 cm)

Maximum Thickness: 2 7/8" (7.30 cm)

Displacement: Forthcoming

Introduced: February '08

Rockers: Natural

Available Densities: 1.7 PCF and 2.0 PCF

Shaper's Comments: Designed for versatility to accommodate a wide range of board styles from Fishes to Big Guy short boards. The manufacturing process ensures uniform density and fusion throughout, thus allowing the shaper to use the maximum width of the blank if necessary. A closer tolerance version to yeild a quick shape and generate less waste.



Call (310) 225-6774 or visit www.usblanks.com

"X" MODEL MAX. THICKNESS 3-1/4"

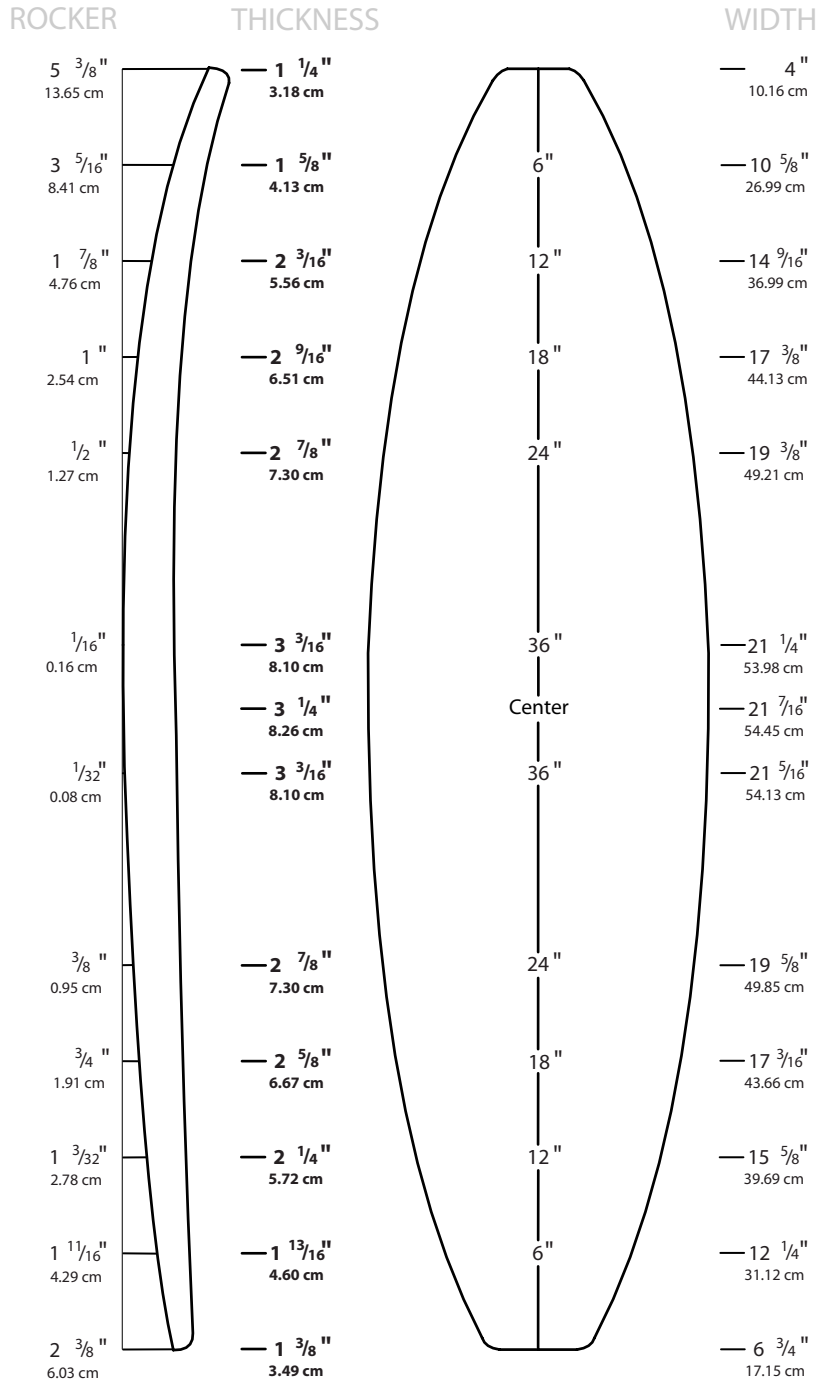

Overall Bottom Length: 6' 9" (205.74 cm)

Tip-to-tip Deck Length: 6' 8" (203.20 cm)

Maximum Width: 21 7/16" (54.45 cm)

Maximum Thickness: 3 1/4" (8.57 cm)

Displacement: Forthcoming

Introduced: April 2007

Rockers: Natural

Available Densities: 1.7 PCF and 2.0 PCF

Shaper's Comments: "Maximum Volume Version" - Designed for maximum versatility to accommodate a wide range of board styles from Fishes to Big Guy short boards. The manufacturing process ensures uniform density and fusion throughout, thus allowing the shaper to use the maximum width of the blank if necessary. The nose and tail have added volume to yield most types of rockers. A real workhorse blank.



7'2" EPS SUPERFUSED

MAX. THICKNESS 2-15/16"

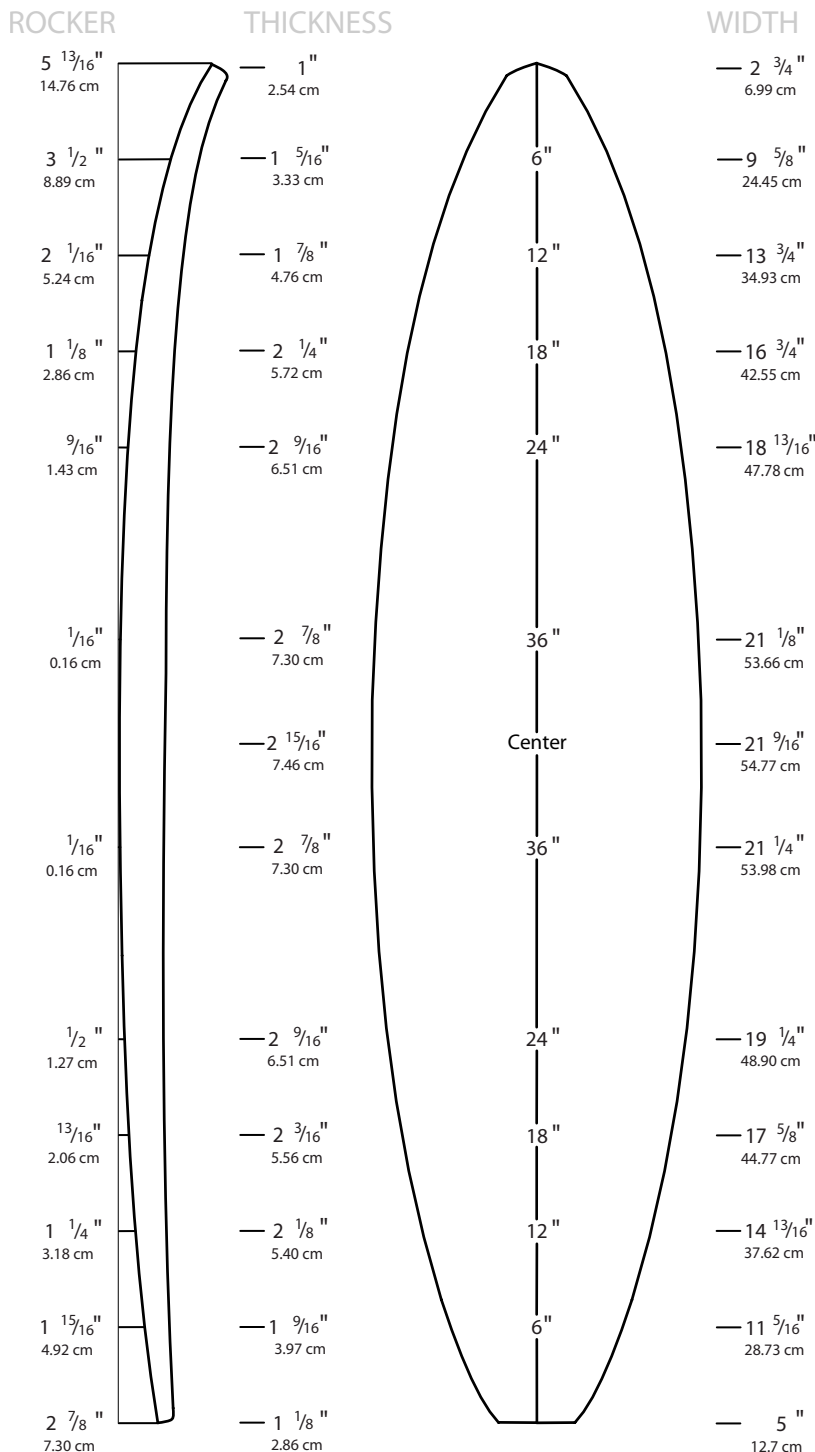

Overall Bottom Length: 7' 2 3/4" (220.35 cm)

Tip-to-tip Deck Length: 7' 1 3/4" (217.81 cm)

Maximum Width: 21 9/16" (54.77 cm)

Maximum Thickness: 2 15/16" (7.46 cm)

Displacement: Forthcoming

Introduced: October 2008

Rockers: Natural

Available Densities: 1.7 PCF and 2.0 PCF

Shaper's Comments: Designed for high performance semi-guns. The added volume in the nose and tail will accommodate a wide variety of rockers.



Call (310) 225-6774 or visit www.usblanks.com

"X" MODEL MAX. THICKNESS 3-5/16"

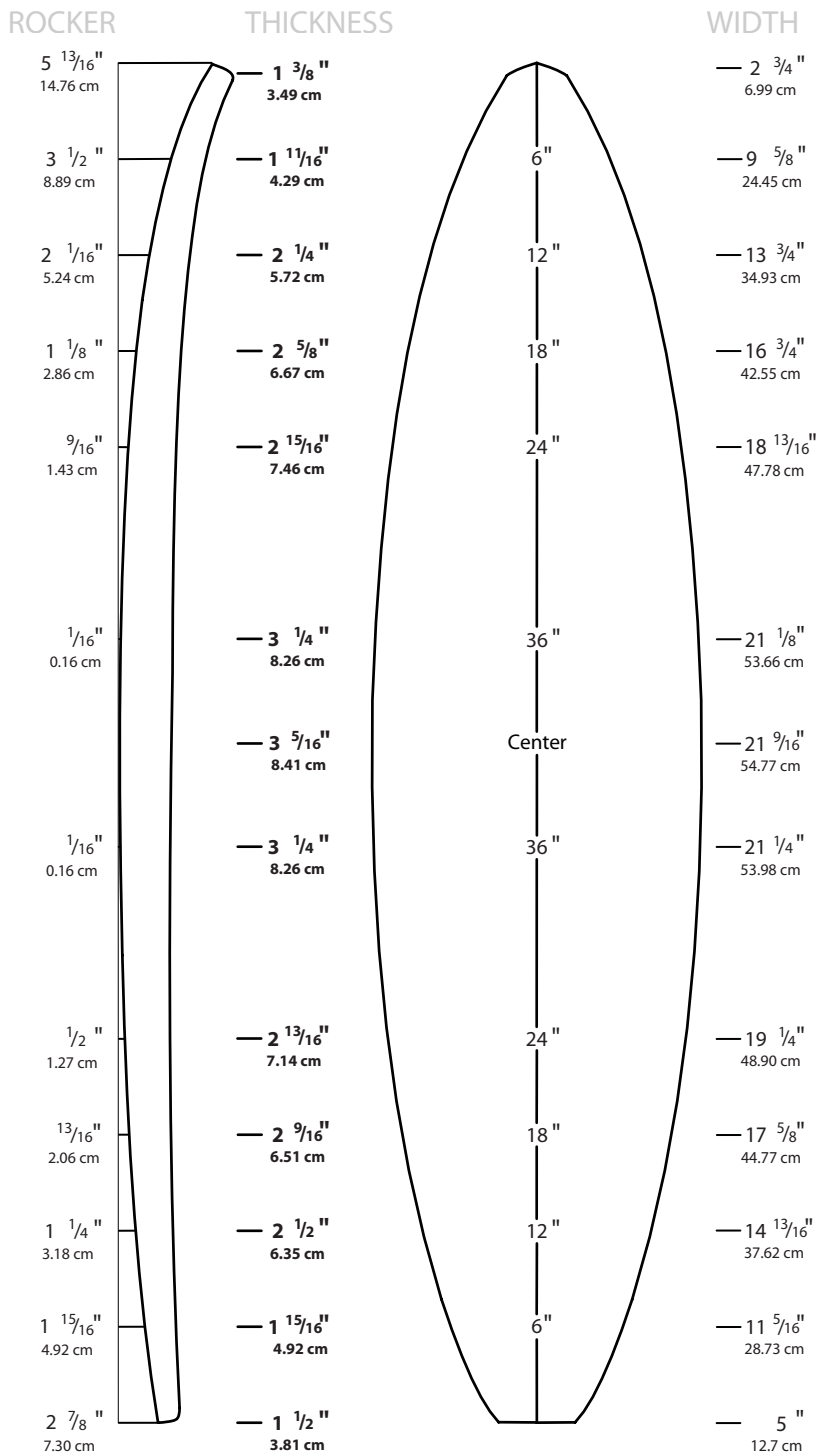

Overall Bottom Length: 7' 2 3/4" (220.35 cm)

Tip-to-tip Deck Length: 7' 1 3/4" (217.81 cm)

Maximum Width: 21 9/16" (54.77 cm)

Maximum Thickness: 3 5/16" (8.41 cm)

Displacement: Forthcoming

Introduced: June 2007

Rockers: Natural

Available Densities: 1.7 PCF and 2.0 PCF

Shaper's Comments: "Maximum Volume Version" - Designed for high performance semi-guns. The added volume in the nose and tail will accommodate a wide variety of rockers.





7'8" EPS SUPERFUSED

Call (310) 225-6774 or visit www.usblanks.com

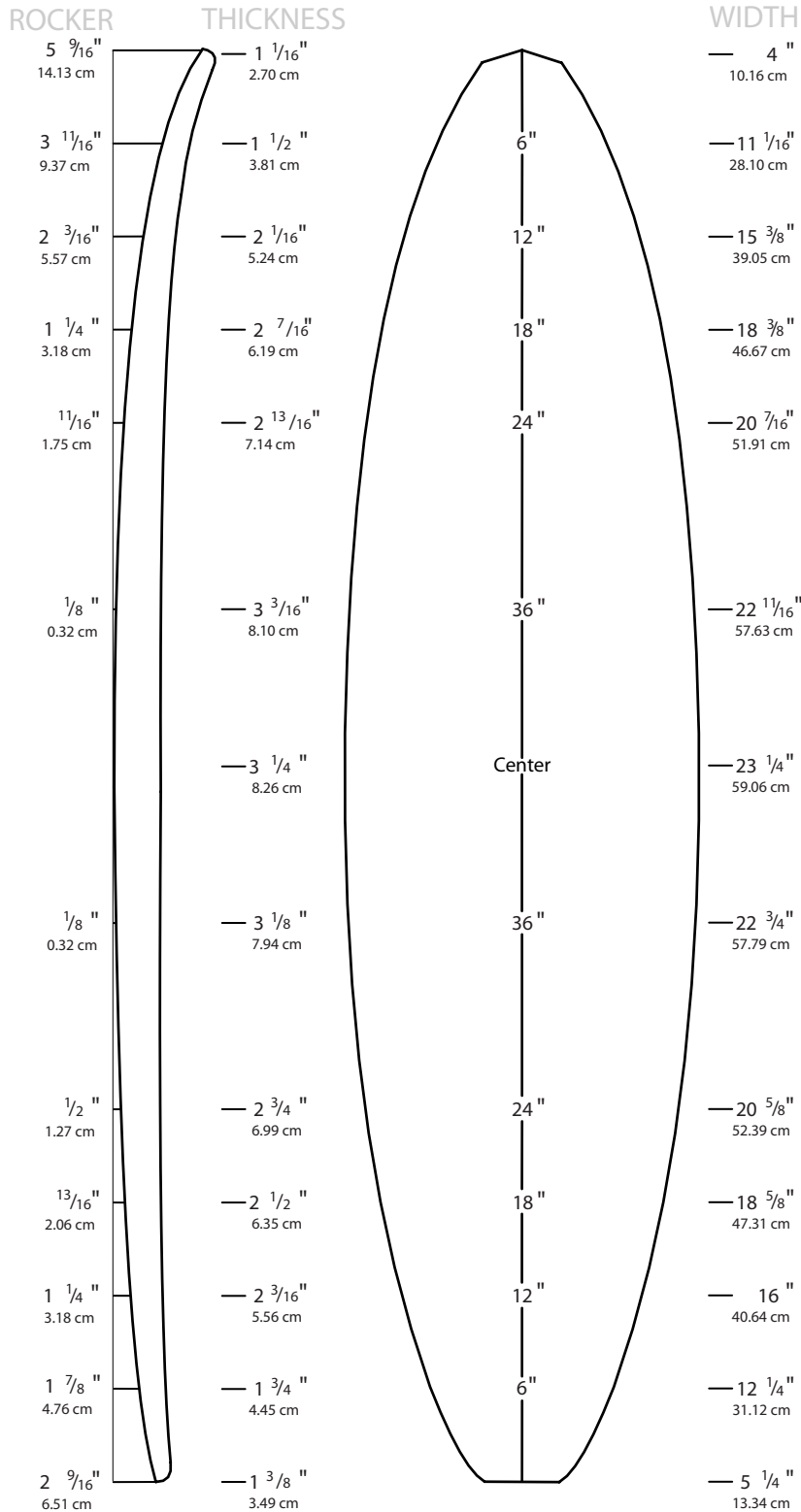

- Overall Bottom Length:** 7' 9" (236.22 cm)
- Tip-to-tip Deck Length:** 7' 7 7/8" (233.36 cm)
- Maximum Width:** 23 1/4" (59.06 cm)
- Maximum Thickness:** 3 1/4" (8.26 cm)
- Displacement:** Forthcoming
- Introduced:** March 2009
- Rockers:** Natural
- Available Densities:** 1.7 PCF and 2.0 PCF

Shaper's Comments: This is a multi-purpose blank which can be used for Fun Boards, Big Guy boards and Guns. The extra volume will accommodate a wide variety of rocker configurations.



Designed and shaped by: **Eric Arakawa**

Call (310) 225-6774 or visit www.usblanks.com

"X" MODEL

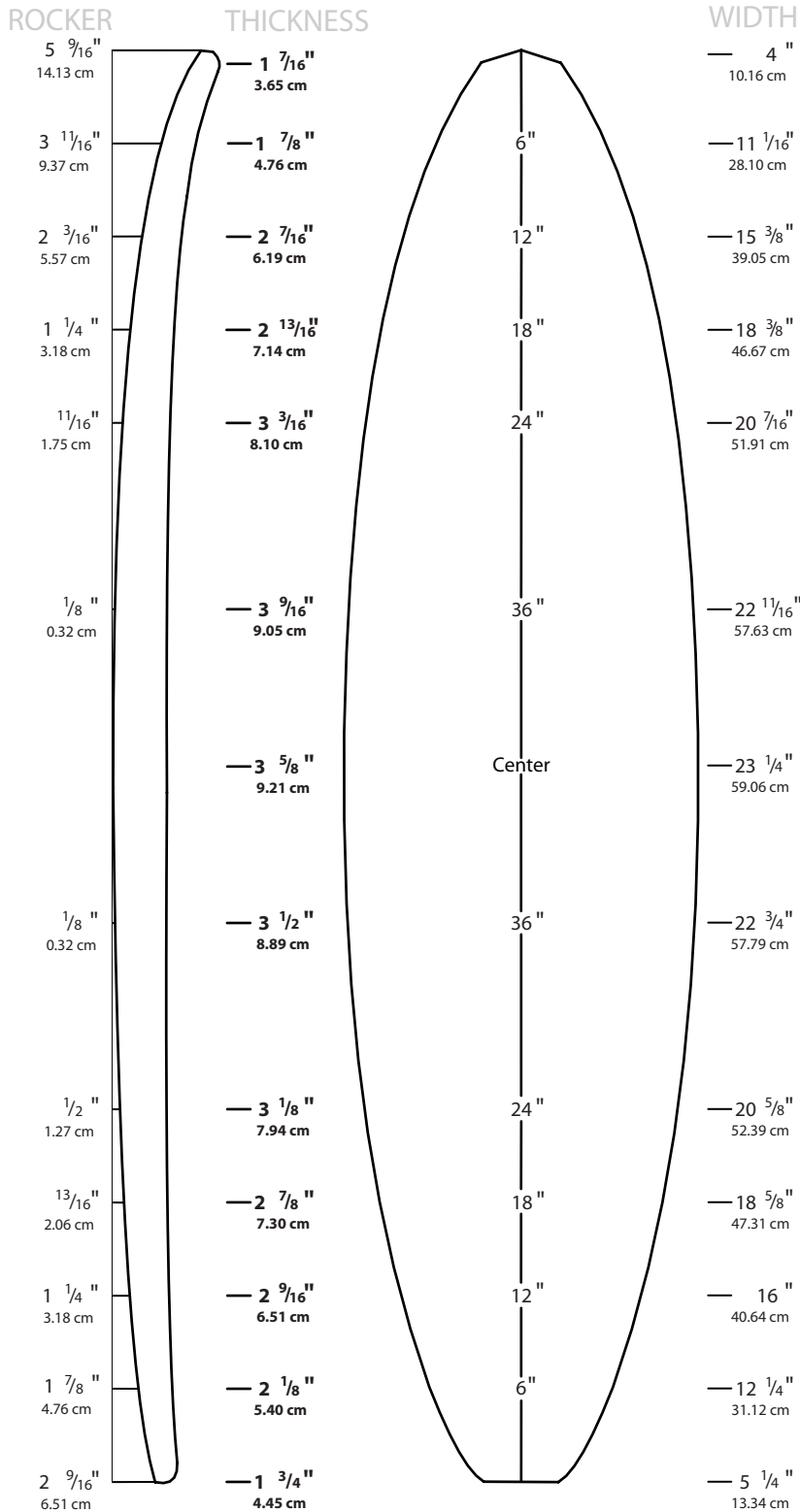

Overall Bottom Length: 7' 9" (236.22 cm)

Tip-to-tip Deck Length: 7' 7 7/8" (233.36 cm)

Maximum Width: 23 1/4" (59.06 cm)

Maximum Thickness: 3 5/8" (9.21 cm)

Displacement: Forthcoming

Introduced: June 2007

Rockers: Natural

Available Densities: 1.7 PCF and 2.0 PCF

Shaper's Comments: "Maximum Volume Version" - This is a multi-purpose blank which can be used for Fun Boards, Big Guy boards and Guns. The extra volume will accommodate a wide variety or rocker configurations.



Designed and shaped by: **Eric Arakawa**



Call (310) 225-6774 or visit www.usblanks.com

8'8" EPS SUPERFUSED

Overall Bottom Length: 8' 7 7/8" (263.84 cm)

Tip-to-tip Deck Length: 8' 7" (261.62 cm)

Maximum Width: 25 1/4" (64.14 cm)

Maximum Thickness: 3 3/16" (8.10 cm)

Displacement: Forthcoming

Introduced: March 2009

Rockers: Natural

Available Densities: 1.7 PCF and 2.0 PCF

Shaper's Comments: This blank is a scaled down version of the 9'8 EPS. The goal was to design an EPS mold plug that would accommodate any longboard shape program in the 7'10" to 8'6" range for machine cutting purposes. After analyzing all the rocker templates from the Clark Foam data base we came up with a "middle of the road" rocker profile, and added thickness to the nose and tail to allow for straight to extreme rocker profiles. The plan shape and width have also been maximized. This blank will be offered in 2 different thicknesses to accommodate for both machine shaping and hand shaping.

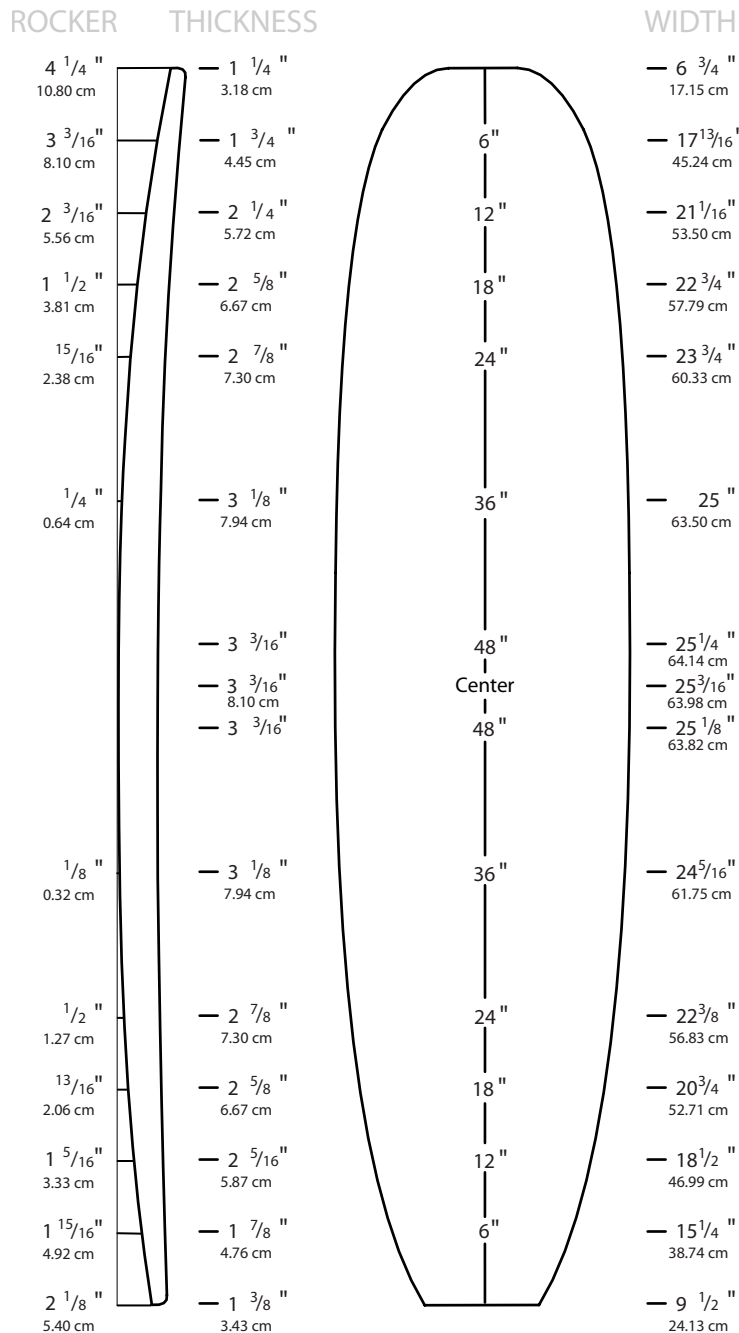

Designed and shaped by: **Rennie Yater**

9'8" EPS SUPERFUSED

MAX. THICKNESS 3"

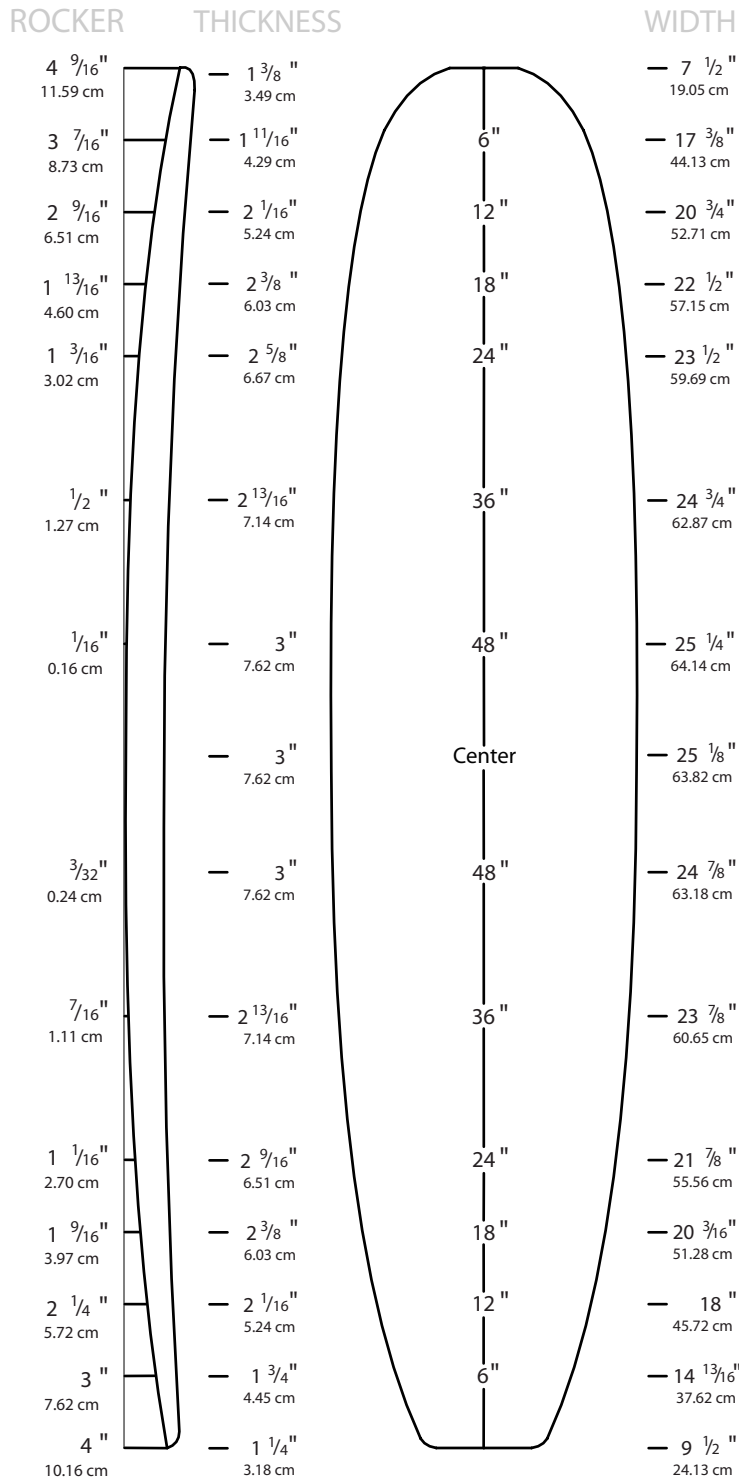

Overall Bottom Length: 9' 8" (274.32 cm)

Tip-to-tip Deck Length: 9' 7 ¹/₄" (274.96 cm)

Maximum Width: 25 ¹/₄" (64.14 cm)

Maximum Thickness: 3" (7.62 cm)

Displacement: Forthcoming

Introduced: December 2007

Rockers: Natural

Available Densities: 2.0 PCF

Shaper's Comments: "Minimum Volume

Version" - This blank is the result of input by several people within the surfboard manufacturing industry. The goal was to design an EPS mold plug that would accommodate any longboard shape program in the 8'10" to 9'6" range for machine cutting purposes. After analyzing all the rocker templates from the Clark Foam data base we came up with a "middle of the road" rocker profile, and added thickness to the nose and tail to allow for straight to extreme rocker profiles. The plan shape and width have also been maximized. This blank is offered in 3 different thicknesses to accommodate for both machine shaping and hand shaping.



Call (310) 225-6774 or visit www.usblanks.com

"X" MODEL

MAX. THICKNESS 3-3/8"

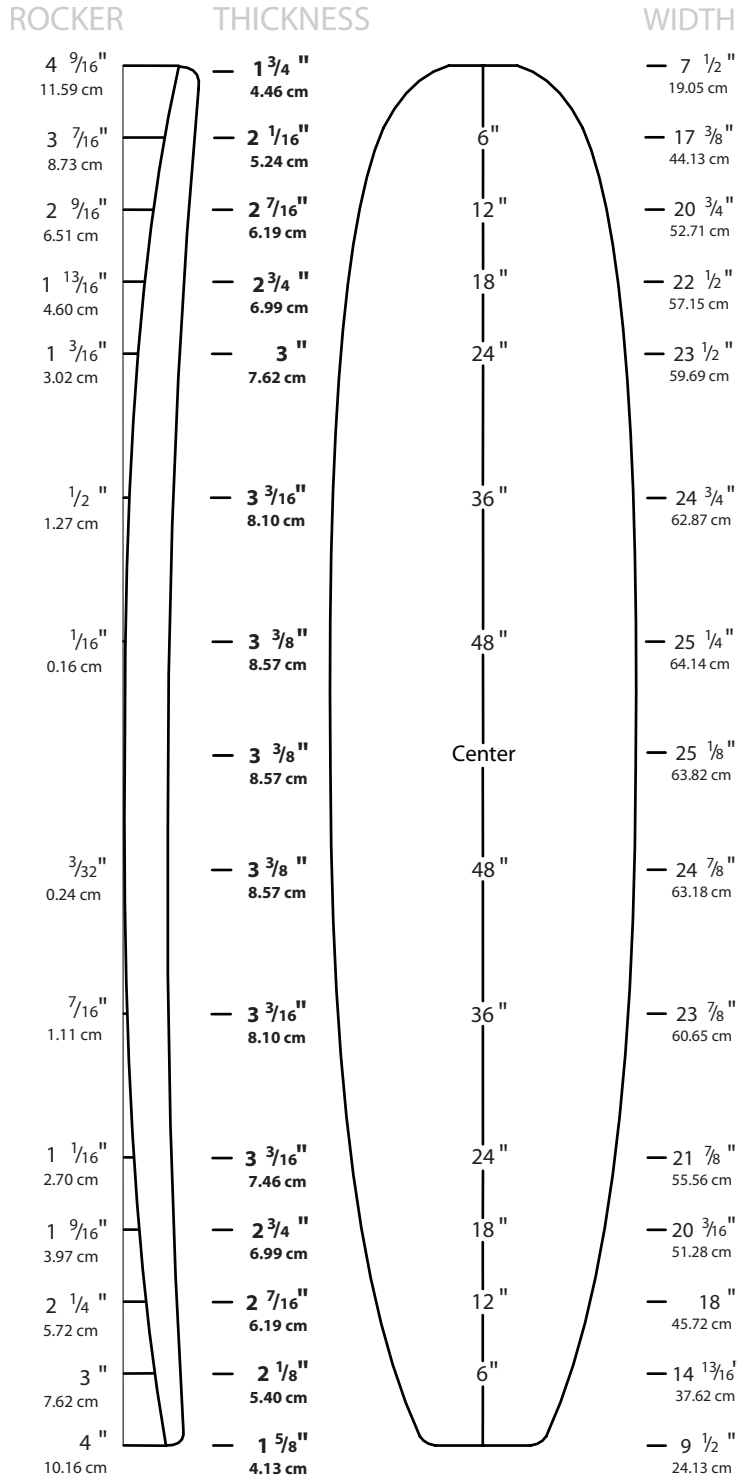

Overall Bottom Length: 9' 8" (274.32 cm)

Tip-to-tip Deck Length: 9' 7 1/4" (274.96 cm)

Maximum Width: 25 1/4" (64.14 cm)

Maximum Thickness: 3 3/8" (8.57 cm)

Displacement: Forthcoming

Introduced: December 2007

Rockers: Natural

Available Densities: 2.0 PCF

Shaper's Comments: "Medium Volume

Version" - This blank is the result of input by several people within the surfboard manufacturing industry. The goal was to design an EPS mold plug that would accommodate any longboard shape program in the 8'10" to 9'6" range for machine cutting purposes. After analyzing all the rocker templates from the Clark Foam data base we came up with a "middle of the road" rocker profile, and added thickness to the nose and tail to allow for straight to extreme rocker profiles. The plan shape and width have also been maximized. This blank is offered in 3 different thicknesses to accommodate for both machine shaping and hand shaping.



Call (310) 225-6774 or visit www.usblanks.com

"X2" MODEL

MAX. THICKNESS 3-3/4"

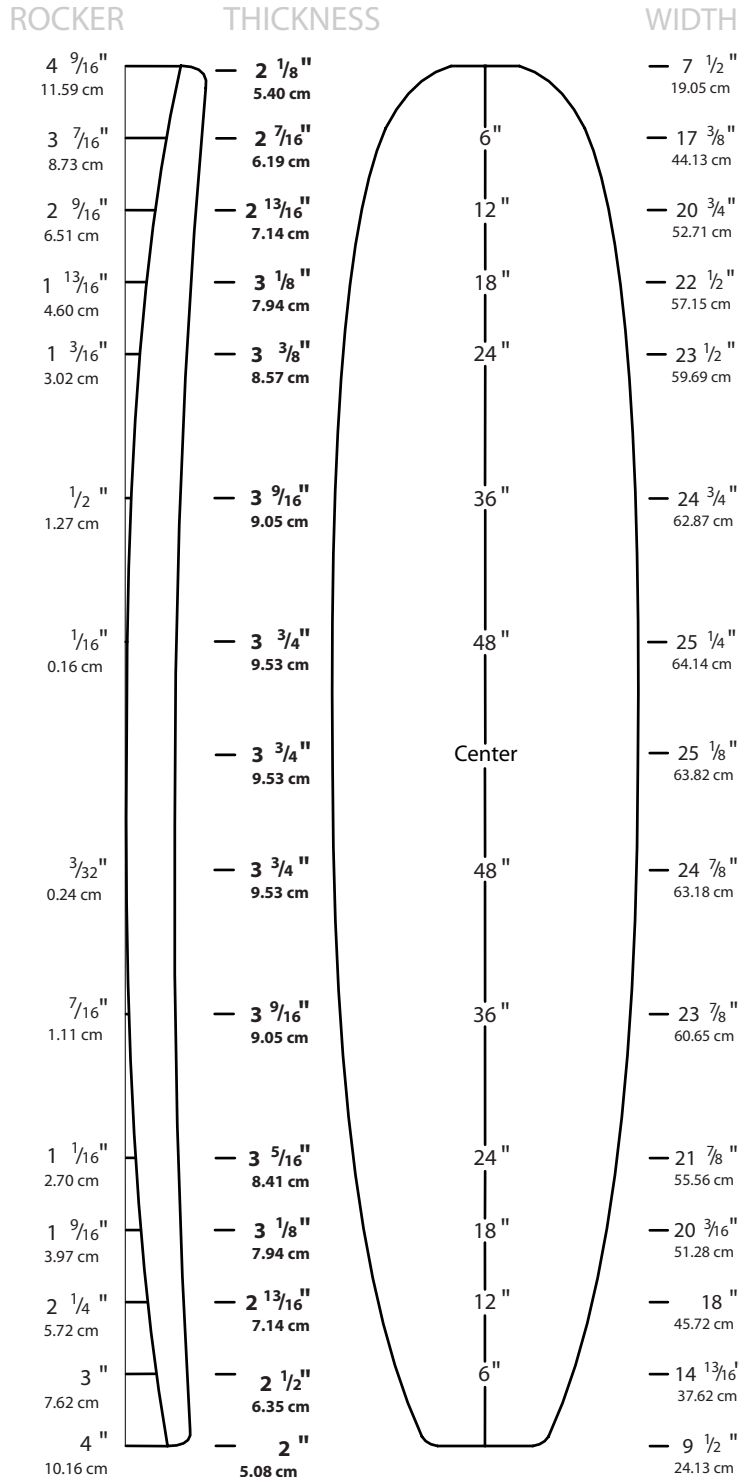

Overall Bottom Length: 9' 8" (274.32 cm)

Tip-to-tip Deck Length: 9' 7 1/4" (274.96 cm)

Maximum Width: 25 1/4" (64.14 cm)

Maximum Thickness: 3 3/4" (9.53 cm)

Displacement: Forthcoming

Introduced: December 2007

Rockers: Natural

Available Densities: 2.0 PCF

Shaper's Comments: "Maximum Volume Version" - This blank is the result of input by several people within the surfboard manufacturing industry. The goal was to design an EPS mold plug that would accommodate any longboard shape program in the 8'10" to 9'6" range for machine cutting purposes. After analyzing all the rocker templates from the Clark Foam data base we came up with a "middle of the road" rocker profile, and added thickness to the nose and tail to allow for straight to extreme rocker profiles. The plan shape and width have also been maximized. This blank is offered in 3 different thicknesses to accommodate for both machine shaping and hand shaping.





EPS BLOCK CUT BLANKS

Manufactured from White Hot Surfboard Foam Billets

Available in 1.5 lb. or 2.0 lb. Density

Size	Type -Shaper	Standard Stringer	Length	Width	Nose Rocker	Tail Rocker	Center Thick.	Nose Thick.	Tail Thick.
6'0"P	Short Board - Patterson	Ply	73.00	20.06	4.63	1.69	2.38	0.88	1.06
6'2"A	Fish - Rawson	Ply	74.25	23.50	4.75	1.81	3.15	1.35	1.45
6'3"RS	Short Board - Rusty	Ply	75.00	21.00	4.87	2.00	2.62	1.25	1.37
63RSX	Short Board - Rusty	Ply	75.00	21.00	4.87	2.00	2.90	1.50	1.65
6'3"WH	Short Board - Rusty	Ply	75.75	20.60	5.60	1.73	2.75	1.40	1.50
6'3"WHX	Short Board - Rusty	Ply	75.75	20.60	5.60	1.73	3.15	1.75	1.87
6'5"A	Fish - Rawson	Ply	77.25	23.50	5.25	1.81	3.35	1.13	1.38
6'8"WH	Short Board - Rusty	Ply	79.00	21.75	5.25	2.34	2.88	1.15	1.25
6'8"WHX	Short Board - Rusty	Ply	79.00	21.75	5.25	2.34	3.50	1.75	1.85
6'9"RS	Short Board - Rusty	Ply	81.00	22.00	5.81	2.40	2.87	1.75	1.25
69RSX	Short Board - Rusty	Ply	81.00	22.00	5.81	2.40	3.18	1.50	1.50
6'10"A	Fish - Rawson	Ply	81.67	24.13	5.19	2.00	3.50	1.38	1.65
7'3"A	Fish - Rawson	1/8" Bass	87.04	24.11	5.50	2.13	3.63	1.38	1.50
7'5"A	Short Board - Rawson	1/8" Bass	87.96	22.06	6.13	2.19	3.00	0.88	1.38
8'1"EA	Short Board - Arakawa	1/8" Bass	96.05	24.14	6.44	2.57	3.44	1.00	1.32
9'2"A	Gun - Rawson	1/8" Bass	110.40	22.46	7.57	2.75	3.57	1.39	1.28
9'3"Y	Long Board - Yater	1/8" Bass	111.30	24.50	4.38	3.50	3.25	1.73	1.41
9'4"B	Long Board - Jones	1/8" Bass	111.44	24.50	4.88	3.63	3.25	0.90	1.32
9'8"Y	Long Board - Yater	1/8" Bass	116.40	24.50	4.50	3.69	3.63	1.45	1.55
9'9"A	Gun - Rawson	1/8" Bass	116.90	22.50	7.75	3.25	3.69	1.38	1.44
10'2"B	Long Board - Jones	1/8" Bass	122.22	24.50	4.82	3.82	3.73	1.27	1.58
9'6"A	SUP	1/8" Bass	114.00	32.00	5.25	4.25	4.93	2.25	1.25
10'0"	SUP	1/8" Bass	120.00	32.00	5.50	4.31	4.93	2.25	1.31
10'4"A	SUP	1/8" Bass	124.00	32.00	4.56	3.75	4.88	2.06	1.81
10'4"B	SUP	1/8" Bass	124.00	32.00	6.25	4.38	4.81	2.31	1.69
11'2"A	SUP	1/8" Bass	134.00	32.00	5.25	4.19	5.00	1.86	1.86
11'2"B	SUP	1/8" Bass	134.00	32.00	6.75	4.75	5.06	2.50	1.81
12'1"	SUP	1/8" Bass	145.00	32.00	6.13	3.38	5.19	2.56	2.50
12'6"A	SUP	1/8" Bass	150.00	32.00	6.31	3.50	5.50	2.86	2.75



9'6" EPS SUP

Call (310) 225-6774 or visit www.usblanks.com

Overall Bottom Length: 9' 6 ⁵/₈" (291.15 cm)

Tip-to-tip Deck Length: 9' 6" (289.56 cm)

Maximum Width: 32" (81.28 cm)

Maximum Thickness: 4 ¹⁵/₁₆" (12.54 cm)

Available Density: 1.5 PCF or 2.0 PCF

Introduced: January 2011

Rockers: Natural

Notes: Forthcoming

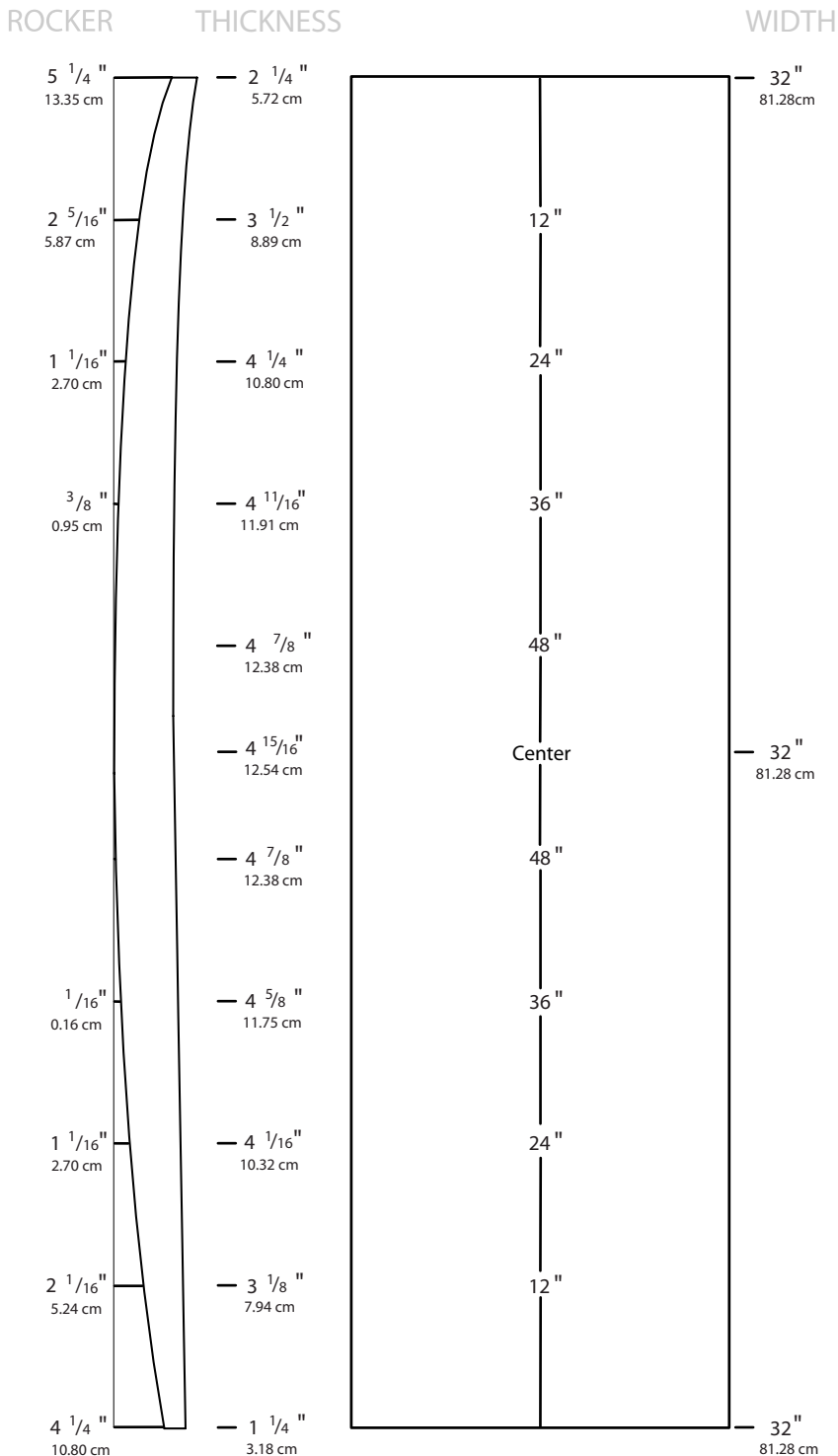

US Blanks™ 10'0" EPS SUP

Call (310) 225-6774 or visit www.usblanks.com

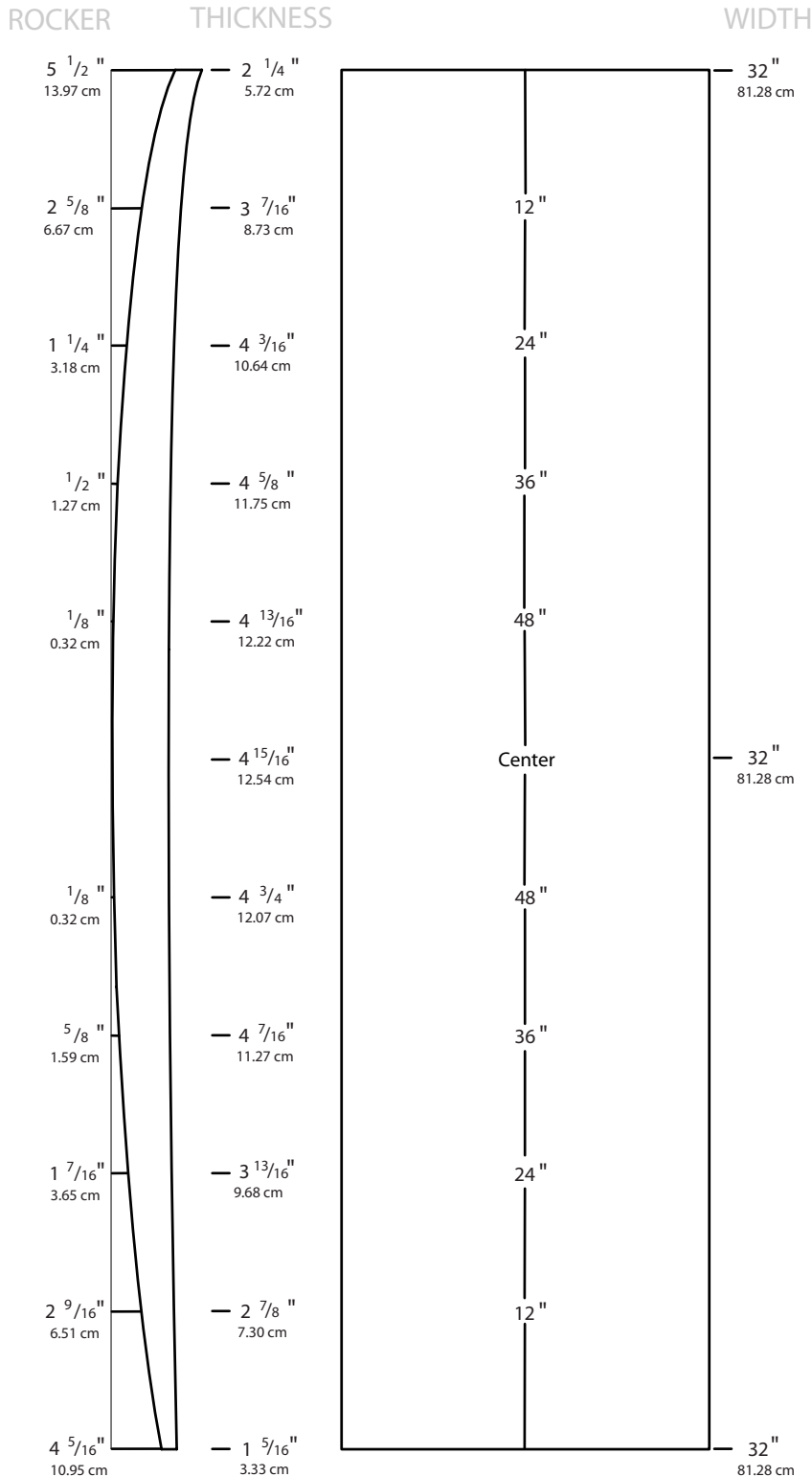

Overall Bottom Length: 10' 0 3/4" (306.71 cm)

Tip-to-tip Deck Length: 10' 0" (304.8 cm)

Maximum Width: 32" (81.28 cm)

Maximum Thickness: 4 15/16" (12.54 cm)

Available Density: 1.5 PCF or 2.0 PCF

Introduced: January 2011

Rockers: Natural

Notes: Forthcoming



US Blanks™ 10'4" EPS A-SUP

Call (310) 225-6774 or visit www.usblanks.com

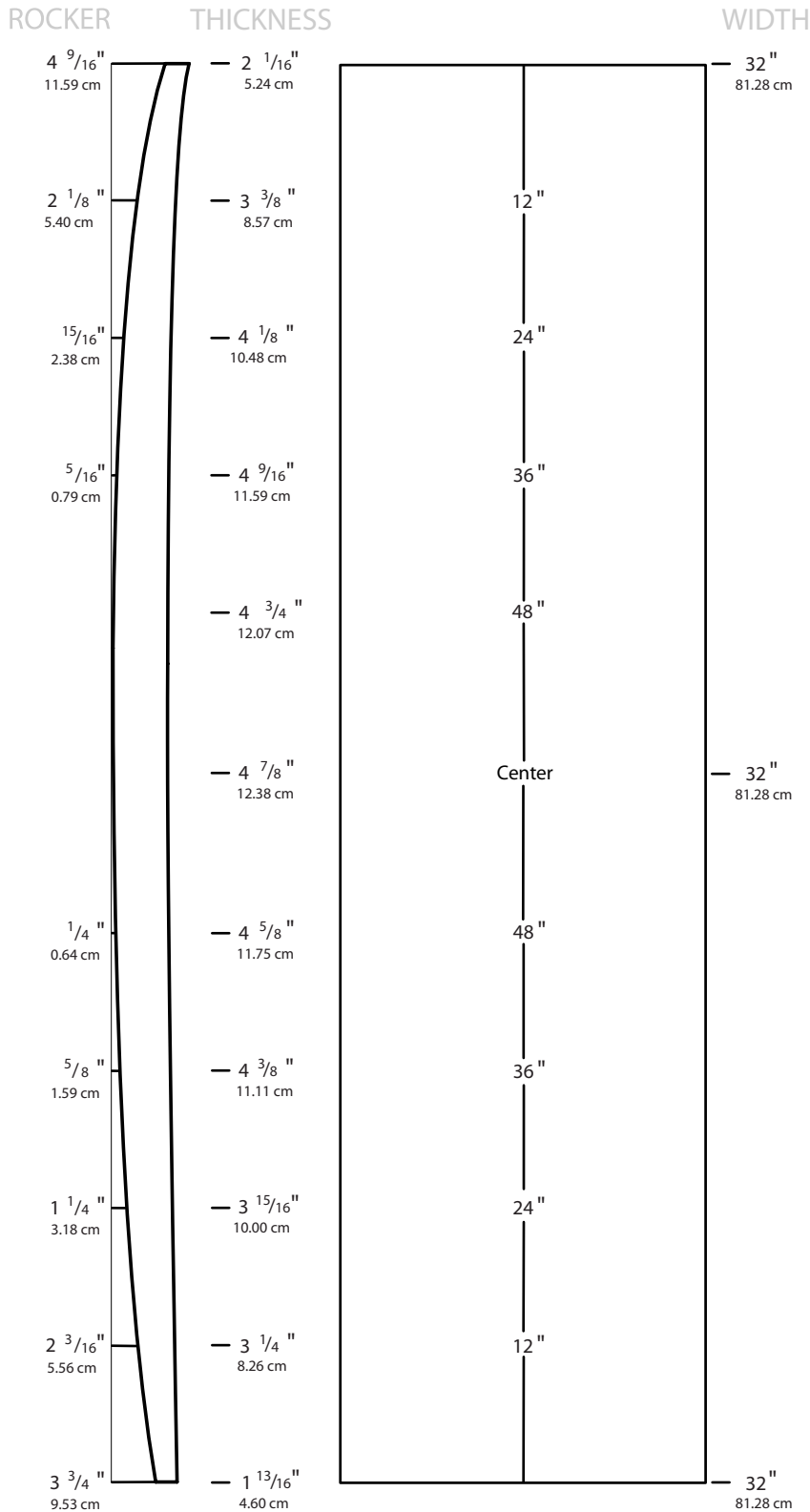

Overall Bottom Length: 10' 5 1/4" (318.14 cm)

Tip-to-tip Deck Length: 10' 4" (314.96 cm)

Maximum Width: 32" (81.28 cm)

Maximum Thickness: 4 7/8" (12.38 cm)

Available Density: 1.5 PCF or 2.0 PCF

Introduced: August 2009

Rockers: Natural

Notes: Forthcoming



US Blanks™ 10'4" EPS B-SUP

Call (310) 225-6774 or visit www.usblanks.com

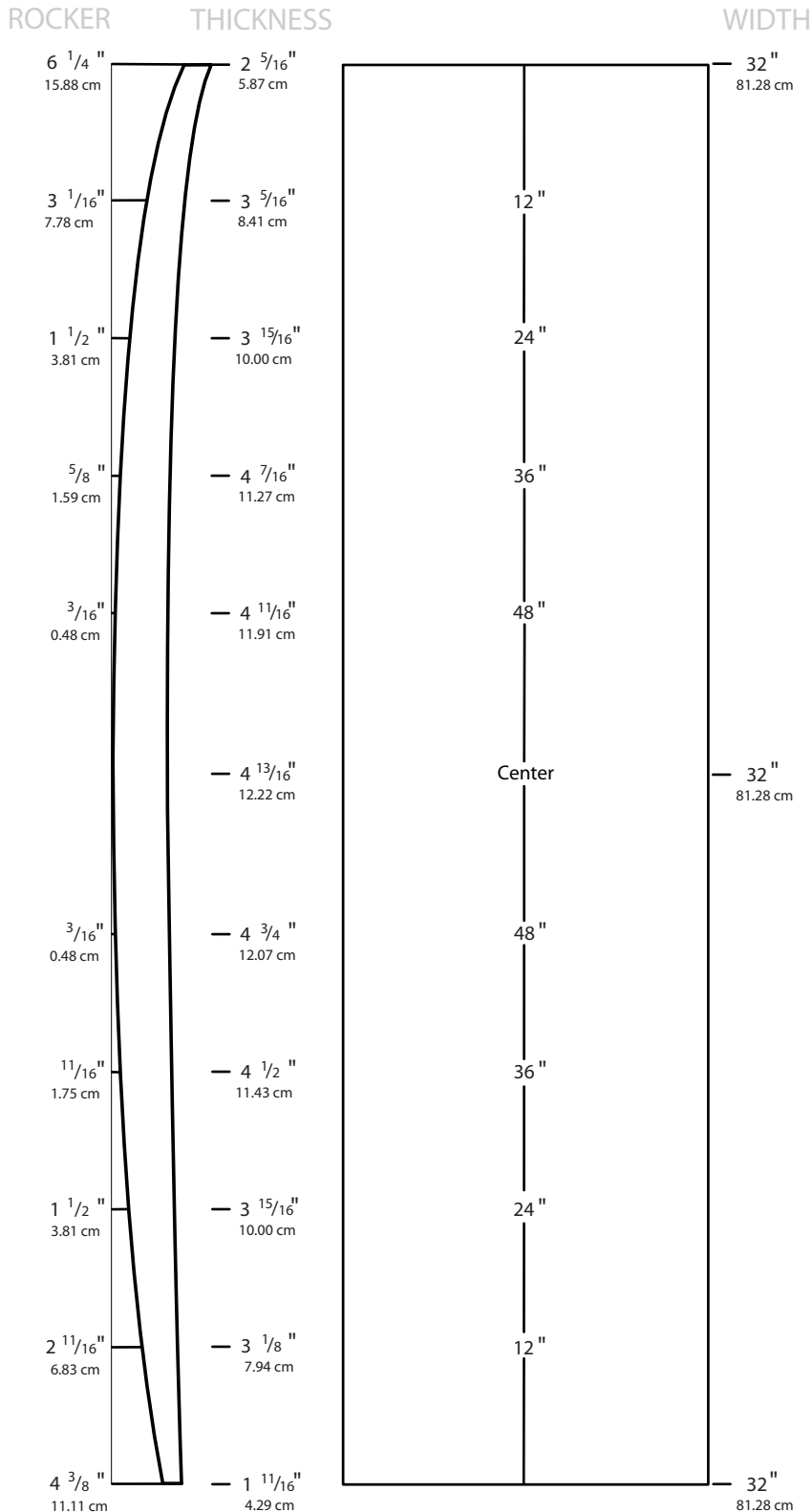

Overall Bottom Length: 10' 5 1/4" (318.14 cm)

Tip-to-tip Deck Length: 10' 4" (314.96 cm)

Maximum Width: 32" (81.28 cm)

Maximum Thickness: 4 13/16" (12.22 cm)

Available Density: 1.5 PCF or 2.0 PCF

Introduced: August 2009

Rockers: Natural

Notes: Forthcoming



Call (310) 225-6774 or visit www.usblanks.com

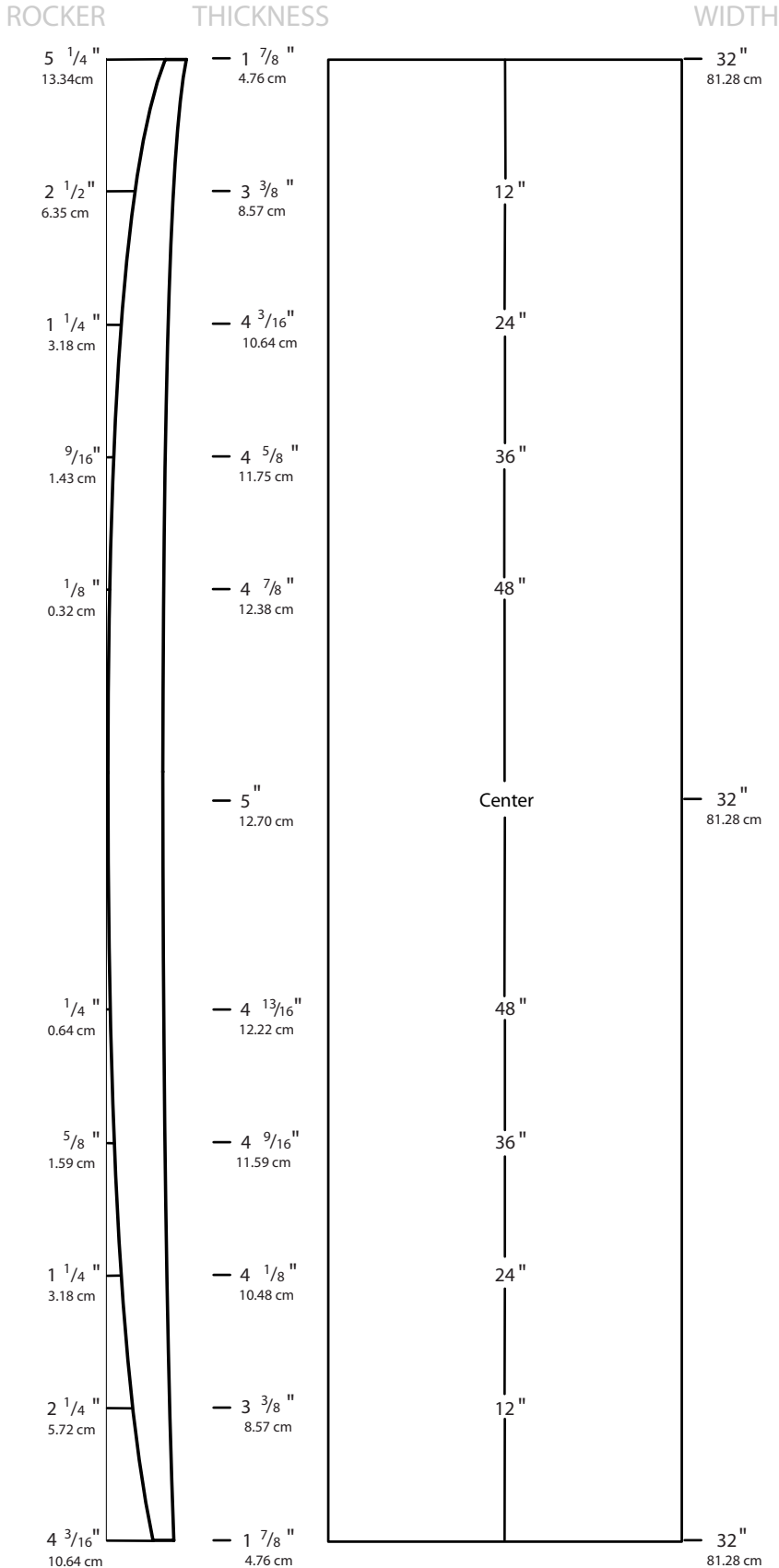

Overall Bottom Length: 11' 3 1/2" (344.17 cm)

Tip-to-tip Deck Length: 11' 2" (340.36 cm)

Maximum Width: 32" (81.28 cm)

Maximum Thickness: 5" (12.7 cm)

Available Densities: 1.5 PCF or 2.0 PCF

Introduced: August 2009

Rockers: Natural

Notes: Forthcoming





11'2" EPS B-SUP

Call (310) 225-6774 or visit www.usblanks.com

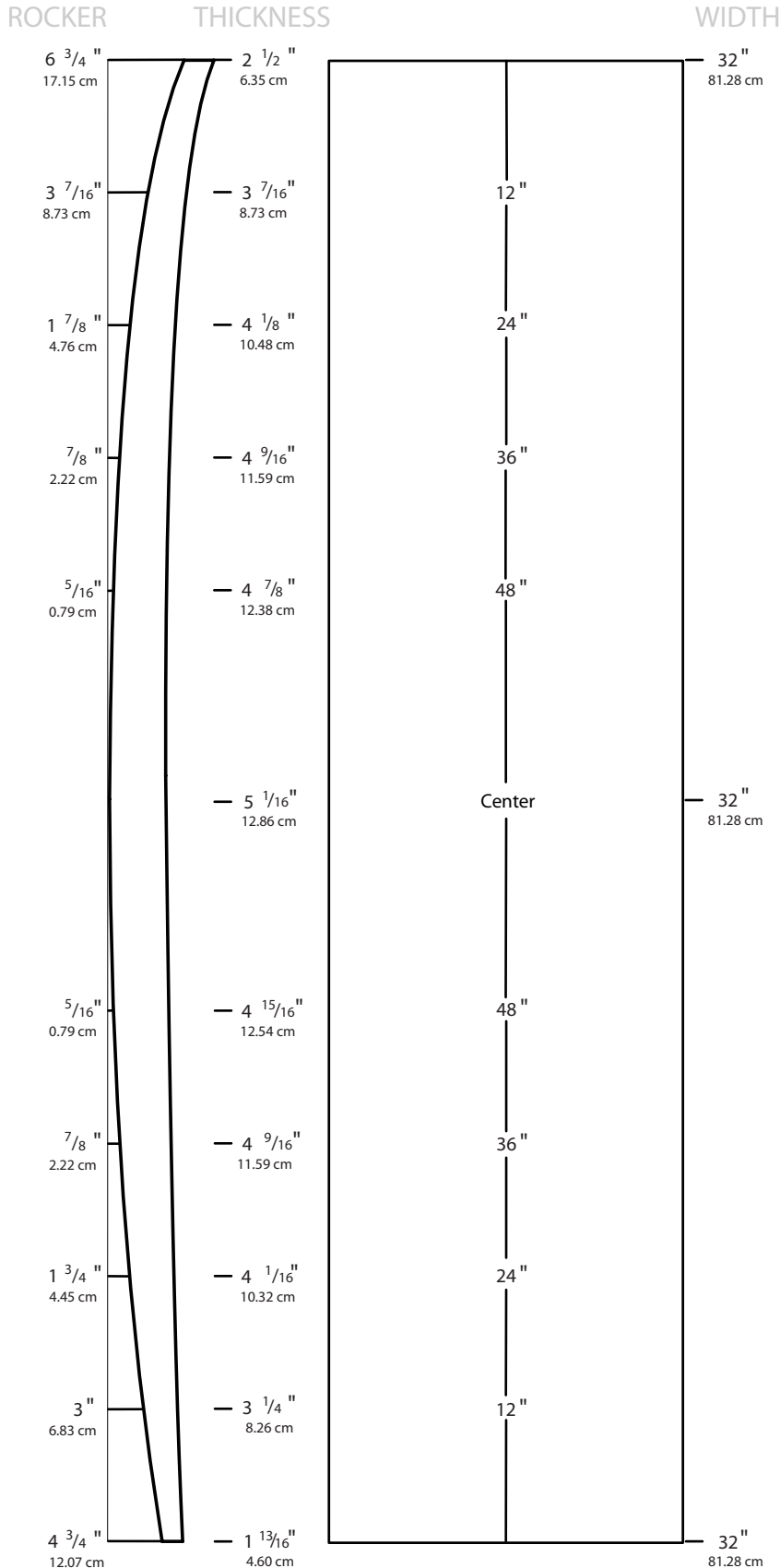

Overall Bottom Length: 11' 3 1/2" (344.17 cm)

Tip-to-tip Deck Length: 11' 2" (340.36 cm)

Maximum Width: 32" (81.28 cm)

Maximum Thickness: 5 1/16" (12.86 cm)

Available Densities: 1.5 PCF or 2.0 PCF

Introduced: August 2009

Rockers: Natural

Notes: Forthcoming



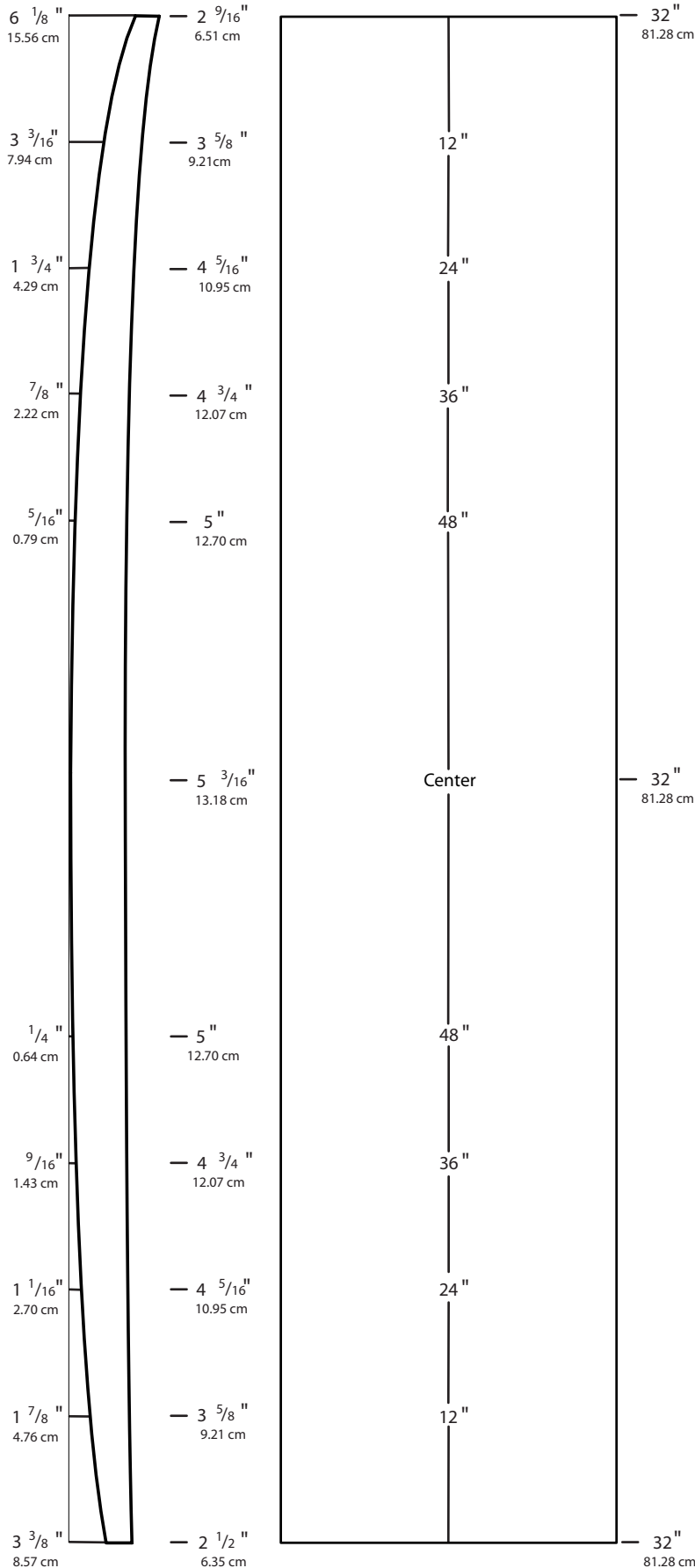

Overall Bottom Length: 12' 2 1/8" (371.16 cm)

Tip-to-tip Deck Length: 12' 1" (368.3 cm)

Maximum Width: 32" (81.28 cm)

Maximum Thickness: 5 3/16" (13.18 cm)

Available Densities: 1.5 PCF or 2.0 PCF

Introduced: August 2009

Rockers: Natural

Notes: Forthcoming



US Blanks™ 12'6" EPS SUP

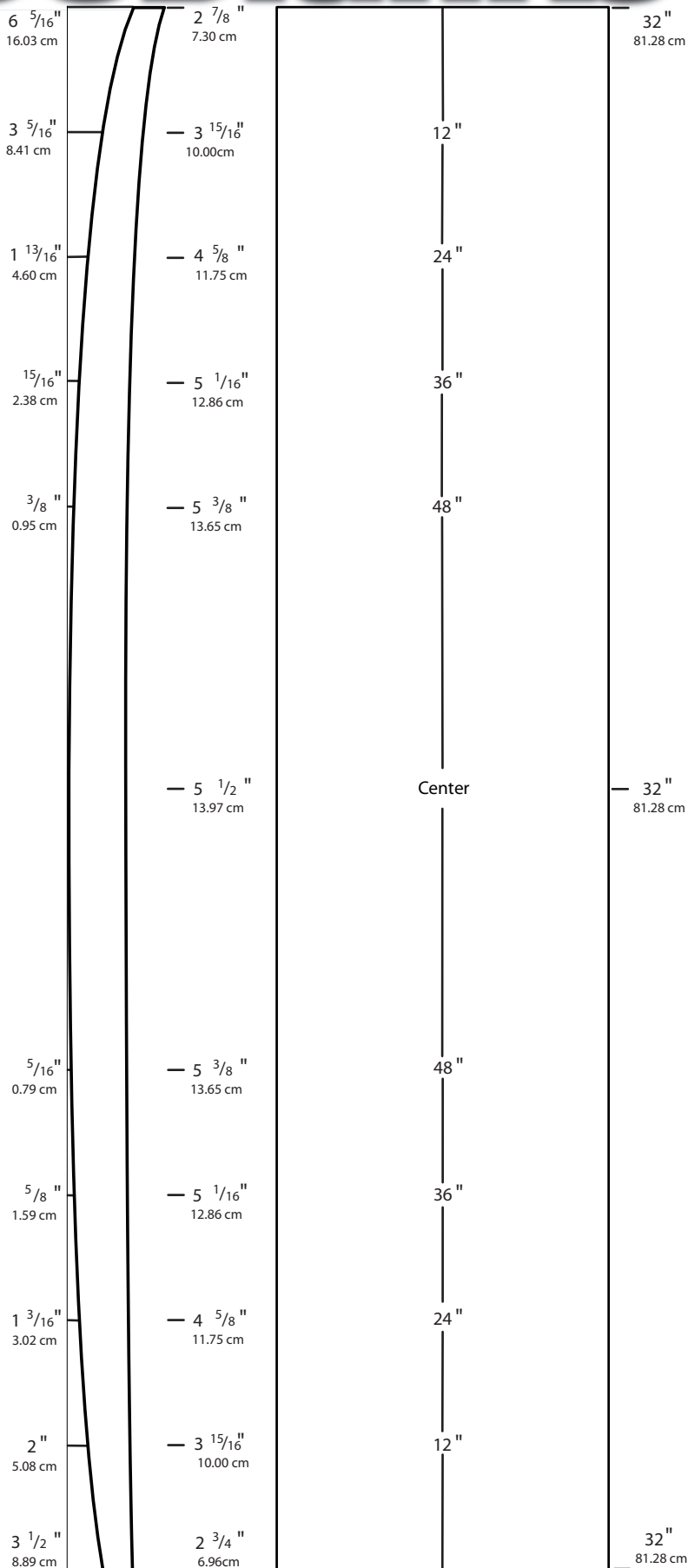

Overall Bottom Length: 12' 7 1/2" (384.81 cm)

Tip-to-tip Deck Length: 12' 6" (381.0 cm)

Maximum Width: 32" (81.28 cm)

Maximum Thickness: 5 1/2" (13.97 cm)

Available Density: 1.5 PCF or 2.0 PCF

Introduced: January 2011

Rockers: Natural

Notes: Forthcoming



Parabolic Stringers

The parabolic template outlines depicted on the following pages are drawn to scale and are representative of the curvature positioning related to the given blank sizes. All templates are named based on their overall length from end to end. When ordering please specify the specific template to be used based on the finished board length. Any short board template can be used in any blank as long as the template is smaller than the blank itself (this does not apply to fish templates). For example, you can request to use the 6'0 parabolic template in the 6'6EA blank. As a general rule the maximum length template that can be used in a blank will be one size smaller than the blank itself (eg. 6'0 template in the 6'2P or the 6'4 template in the 6'6EA, etc.) We will only use the same length template in a blank when specifically requested by a customer. All templates can also be used in our Superfused EPS blanks.

Our “stock” parabolic templates can be adjusted in or out in the tail to accommodate a narrower or wider outline. Be aware that all dimensions from nose to tail will be affected when making this adjustment. Upon request customers may also submit “custom” templates to be kept as private outlines. Custom template set up will be subject to a one-time surcharge.

The most common stringer thicknesses in parabolic blanks are 3/32”, 1/8” and 4mm ply (5/32”). The allowed maximum stringer thickness used for the 5'11 Fish and 6'4 Fish outlines is 3/32”.

We suggest using the “natural” rocker in all parabolic blanks whenever possible. Parabolic stringers do not react to (or hold) rocker adjustments in the same manner as when adjusted from a center stringer. For this reason **will not guarantee precise tolerances** when making “custom rocker adjustments” in parabolic blanks.

Parabolic Polyurethane blanks can also be ordered in colored foam. When ordering colored parabolic blanks with different colored rails we require that you order a minimum of 2 blanks (one of each color) as the colors will be exchanged between the 2 blanks.

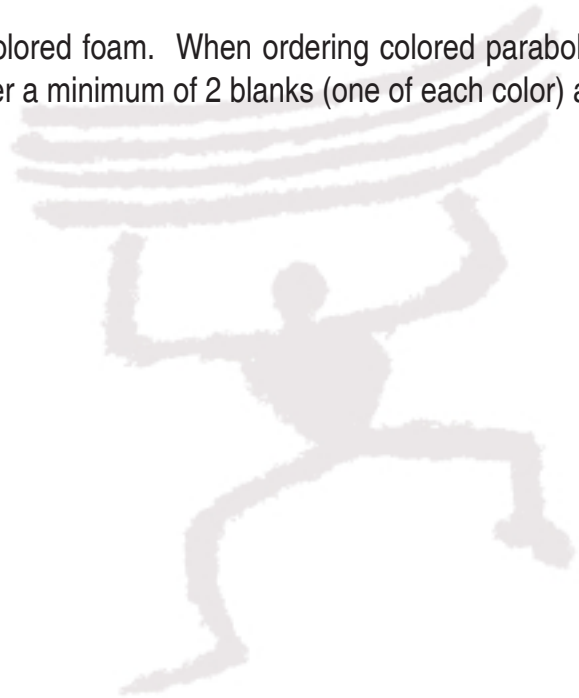



Call (310) 225-6774 or visit www.usblanks.com

5'9" P PARABOLIC

Overall Template Length: 5' 8" (172.72 cm)

Blank Width: 19 1/16" (48.42 cm)

(1/2" narrower than standard 5'9P)

Notes: This template is suitable for high performance shortboard shapes 5'8 and under.

* * All parabolic dimensions are "inside widths" measured across from cut to cut. Extra width must be added to the dimensions listed to account for thickness of stringers. Overall blank width is narrower due to the thickness of material removed during the cutting process.

Available Rockers:

5'9P Parabolic Natural Rocker - 5'8 template

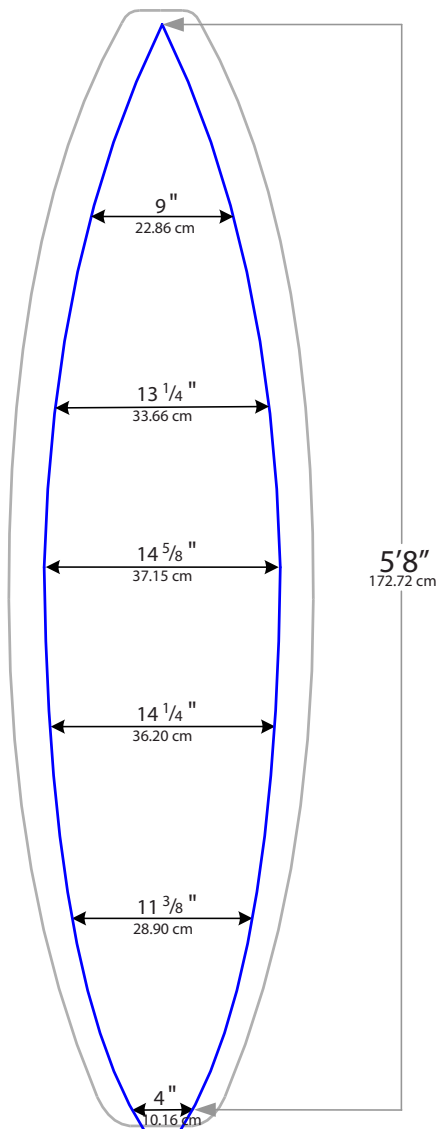



Call (310) 225-6774 or visit www.usblanks.com

6'0" P PARABOLIC

Overall Template Length: 5' 10" (177.80 cm)

Blank Width: 19 9/16" (49.69 cm)
(1/2" narrower than standard 6'0P)

Notes: This template is suitable for high performance short board shapes 5'10" and under.

* * All parabolic dimensions are "inside widths" measured across from cut to cut. Extra width must be added to the dimensions listed to account for thickness of stringers. Overall blank width is narrower due to the thickness of material removed during the cutting process.

Available Rockers:

6'0P Parabolic Natural Rocker - 5'10 template

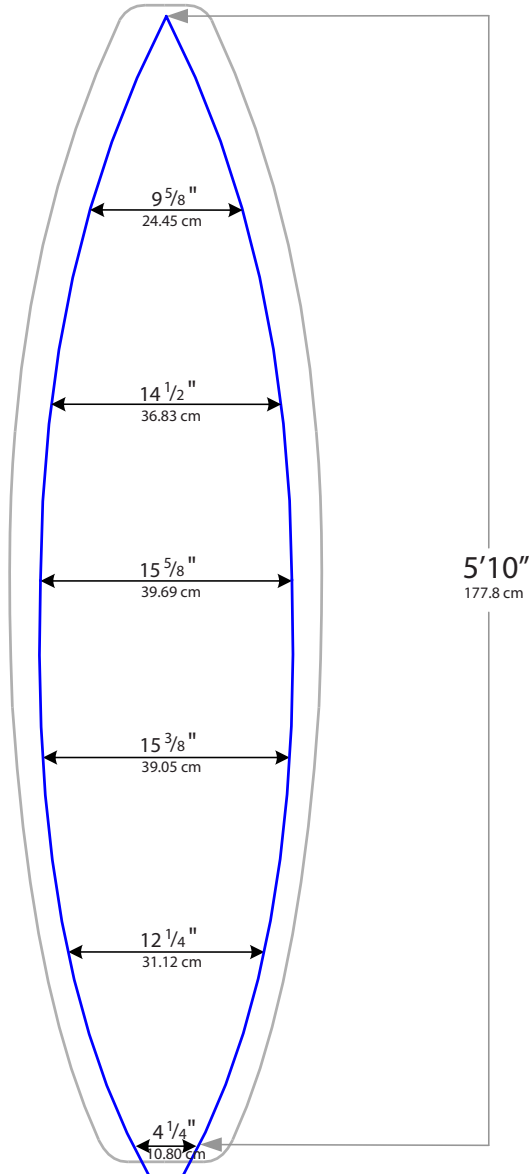



Call (310) 225-6774 or visit www.usblanks.com

6'2" A PARABOLIC

Overall Template Length: 5' 11" (180.34 cm)

Blank Width: 23 1/8" (58.74 cm)
(1/2" narrower than standard 6'2A)

Notes: This template is suitable for high performance FISH board shapes 5'11" and under.

Maximum stringer thickness allowed = 3/32"

* * All parabolic dimensions are "inside widths" measured across from cut to cut. Extra width must be added to the dimensions listed to account for thickness of stringers. Overall blank width is narrower due to the thickness of material removed during the cutting process.

Available Rockers:

6'2A Parabolic Natural Rocker - 5'11 FISH template

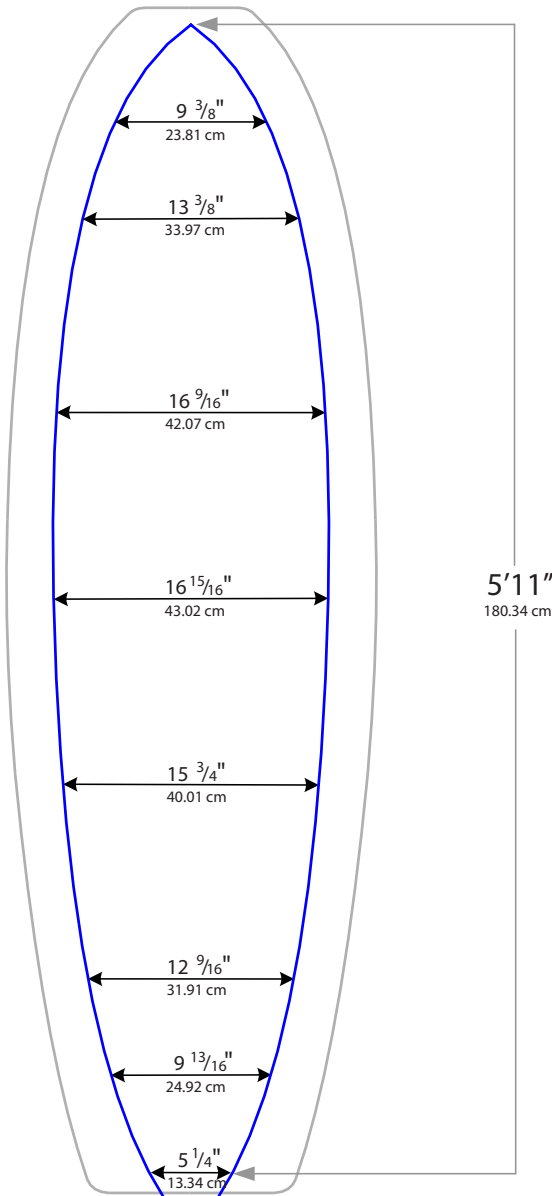



Call (310) 225-6774 or visit www.usblanks.com

6'2" P PARABOLIC

Overall Template Length: 6' 0" (182.88 cm)

Blank Width: 20 1/8" (51.12 cm)

(1/2" narrower than standard 6'2P)

Notes: This template is suitable for high performance short board shapes 6'0" and under.

* * All parabolic dimensions are "inside widths" measured across from cut to cut. Extra width must be added to the dimensions listed to account for thickness of stringers. Overall blank width is narrower due to the thickness of material removed during the cutting process.

Available Rockers:

- 6'2P Parabolic Natural Rocker - 6'0 template
- 6'2P Parabolic +1/2"N18" Rocker - 6'0 template
- 6'2P Parabolic Natural Rocker - 5'10 template

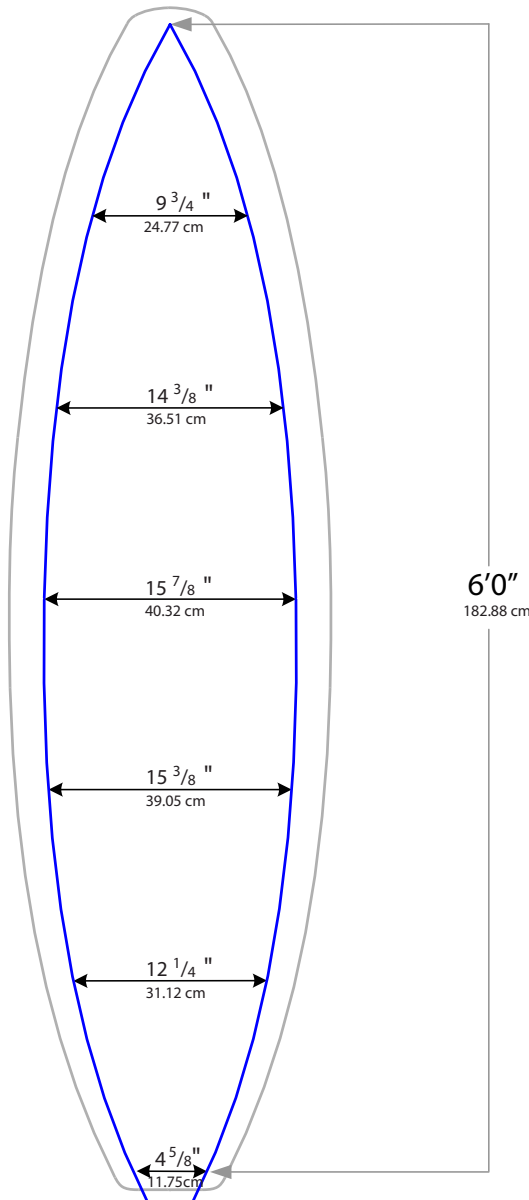



Call (310) 225-6774 or visit www.usblanks.com

6'3" EA PARABOLIC

Overall Template Length: 6' 2" (187.96 cm)

Blank Width: 20 ⁵/₁₆" (51.59 cm)

(1/2" narrower than standard 6'3 EA)

Notes: This template is suitable for high performance short board shapes 6'2" and under.

* * All parabolic dimensions are "inside widths" measured across from cut to cut. Extra width must be added to the dimensions listed to account for thickness of stringers. Overall blank width is narrower due to the thickness of material removed during the cutting process.

Available Rockers:

- 6'3EA Parabolic Natural Rocker - 6'2 template
- 6'3EA Parabolic Natural Rocker - 6'0 template
- 6'3EA Parabolic Natural Rocker - 5'10 template

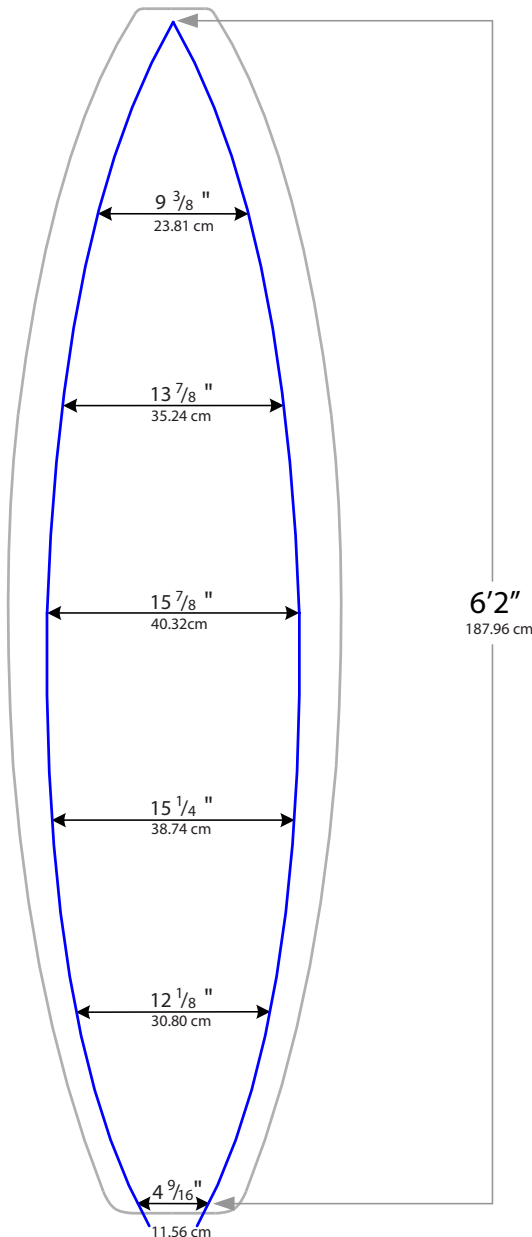



Call (310) 225-6774 or visit www.usblanks.com

6'5" A PARABOLIC

Overall Template Length: 6' 4" (193.04 cm)

Blank Width: 23 1/8" (58.74 cm)

(1/2" narrower than standard 6'5A)

Notes: This template is suitable for high performance FISH board shapes 6'4" and under.

Maximum stringer thickness allowed = 3/32"

* * All parabolic dimensions are "inside widths" measured across from cut to cut. Extra width must be added to the dimensions listed to account for thickness of stringers. Overall blank width is narrower due to the thickness of material removed during the cutting process.

Available Rockers:

6'5A Parabolic Natural Rocker - 6'4 Fish template

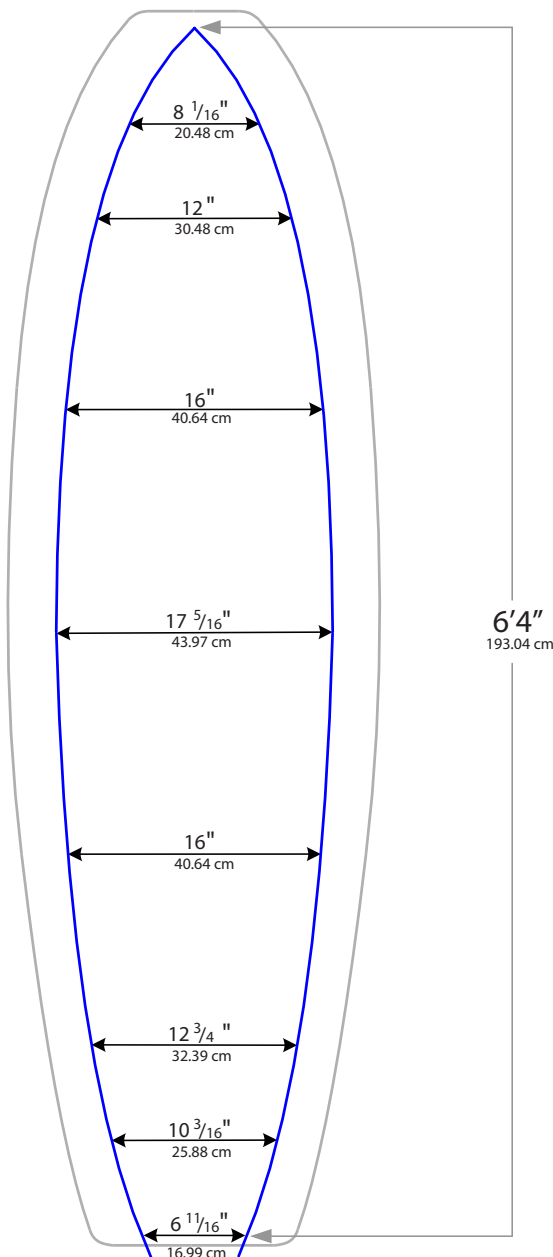



Call (310) 225-6774 or visit www.usblanks.com

6'6"EA PARABOLIC

Overall Template Length: 6' 4" (193.04 cm)

Blank Width: 20 ¹⁵/₁₆" (53.18 cm)

(¹/₂" narrower than standard 6'6EA)

Notes: This template is suitable for high performance short board shapes 6'4" and under.

* * All parabolic dimensions are "inside widths" measured across from cut to cut. Extra width must be added to the dimensions listed to account for thickness of stringers. Overall blank width is narrower due to the thickness of material removed during the cutting process.

Available Rockers:

- 6'6EA Parabolic Natural Rocker - 6'4 template
- 6'6EA Parabolic Natural Rocker - 6'2 template
- 6'6EA Parabolic Natural Rocker - 6'0 template
- 6'6EA Parabolic Natural Rocker - 5'10 template

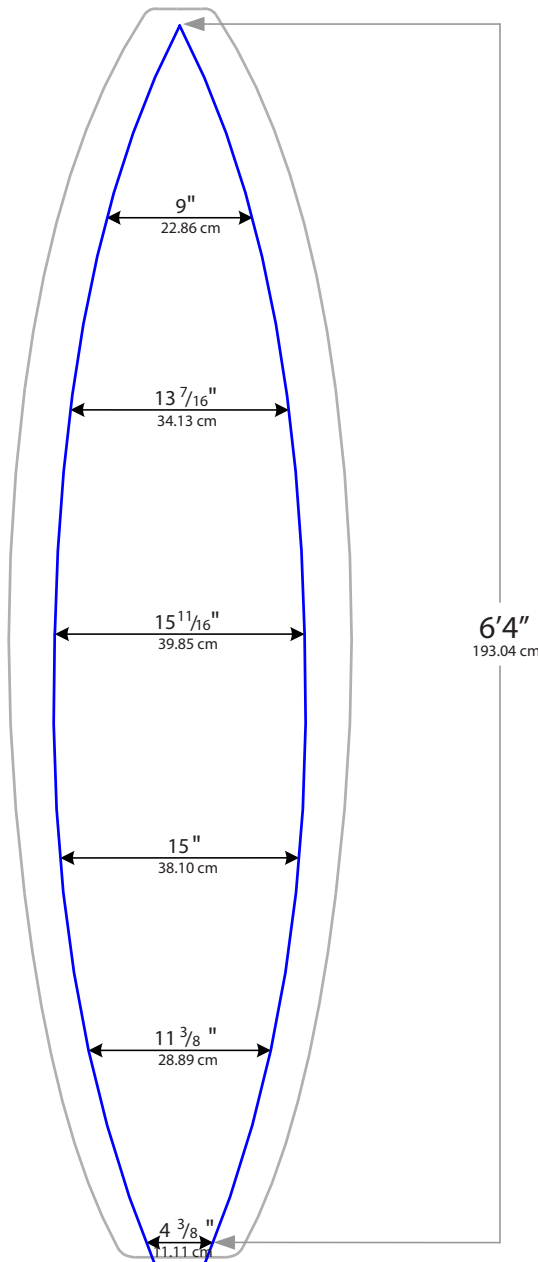



Call (310) 225-6774 or visit www.usblanks.com

6'7" P PARABOLIC

Overall Template Length: 6' 6" (198.12 cm)

Blank Width: 21" (53.34 cm)

(1/2" narrower than standard 6'7P)

Notes: This template is suitable for high performance short board shapes 6'6" and under.

* * All parabolic dimensions are "inside widths" measured across from cut to cut. Extra width must be added to the dimensions listed to account for thickness of stringers. Overall blank width is narrower due to the thickness of material removed during the cutting process.

Available Rockers:

6'7P Parabolic Natural Rocker - 6'6" template

6'7P Parabolic +1/4" T20" Rocker - 6'4" template

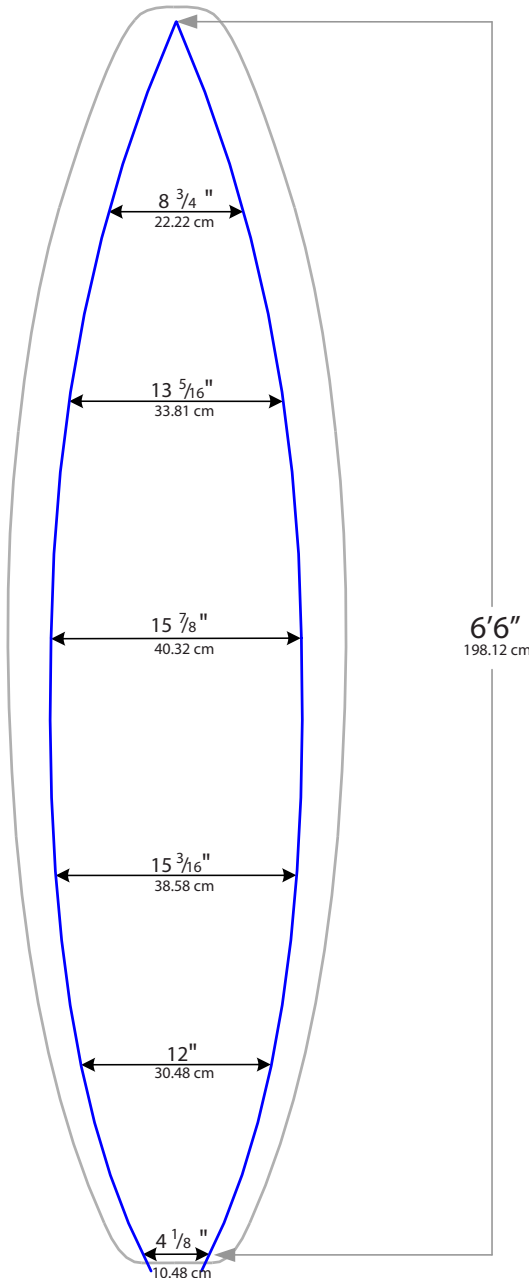



Call (310) 225-6774 or visit www.usblanks.com

6'9" EA PARABOLIC

Overall Template Length: 6' 8" (203.20 cm)

Blank Width: 20 ¹³/₁₆" (49.69 cm)

(1/2" narrower than standard 6'9EA)

Notes: This template is suitable for high performance short board shapes 6'8" and under.

* * All parabolic dimensions are "inside widths" measured across from cut to cut. Extra width must be added to the dimensions listed to account for thickness of stringers. Overall blank width is narrower due to the thickness of material removed during the cutting process.

Available Rockers:

6'9EA Parabolic Natural Rocker - 6'8 template

6'9EA Parabolic Natural Rocker - 6'6 template

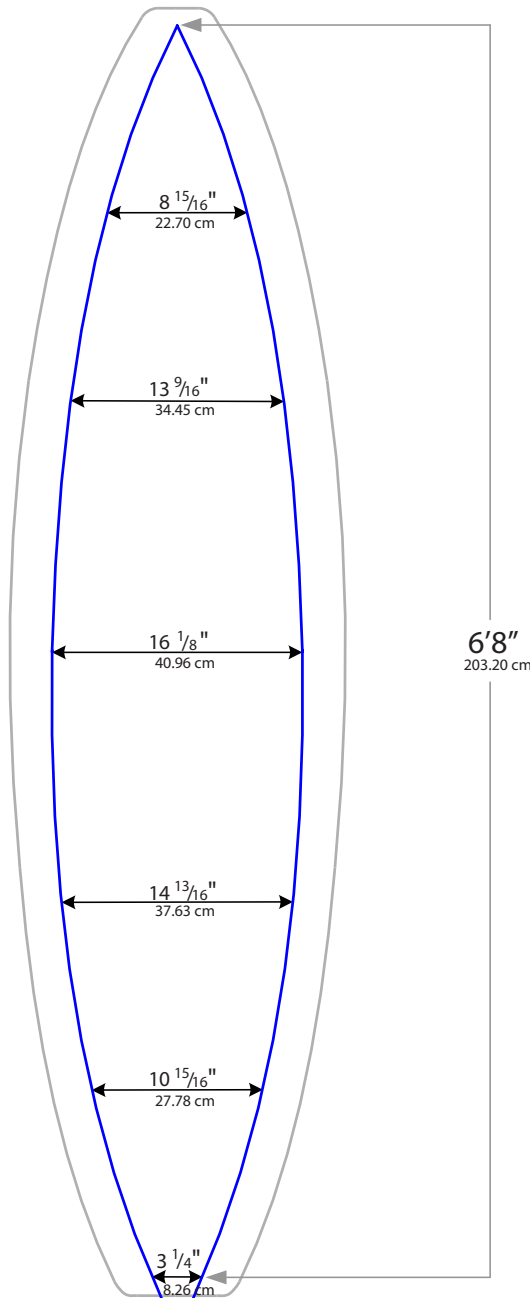



Call (310) 225-6774 or visit www.usblanks.com

7'1" EA PARABOLIC

Overall Template Length: 7' 0" (213.36 cm)

Blank Width: 22 ³/₁₆" (57.63 cm)

(¹/₂" narrower than standard 7'1EA)

Notes: This template is suitable for high performance short board shapes 7'0" and under.

* * All parabolic dimensions are "inside widths" measured across from cut to cut. Extra width must be added to the dimensions listed to account for thickness of stringers. Overall blank width is narrower due to the thickness of material removed during the cutting process.

Available Rockers:

7'1EA Parabolic Natural Rocker - 7'0 template

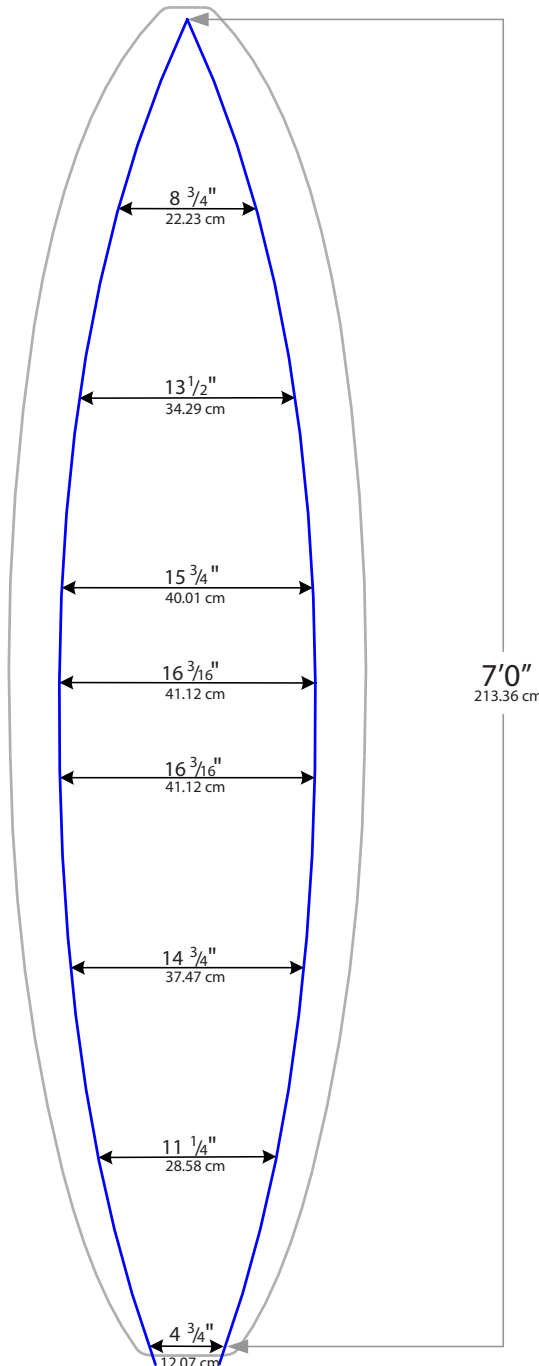

9'4" B PARABOLIC

Outline "A"

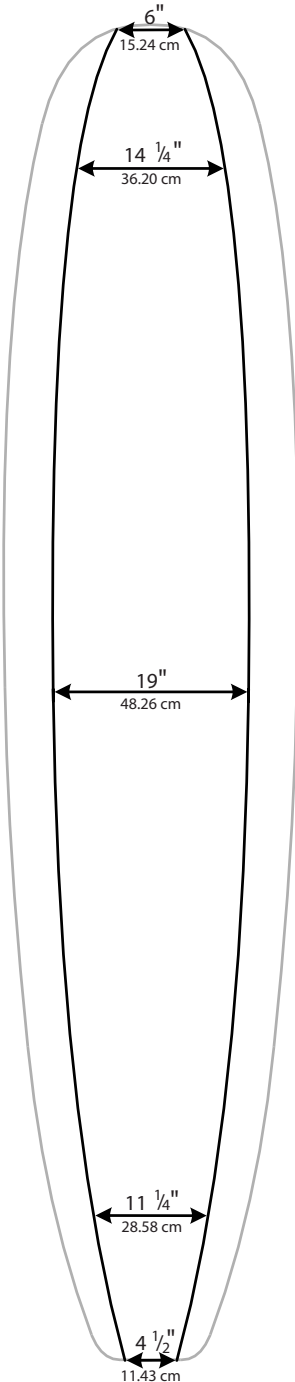

Outline "B"

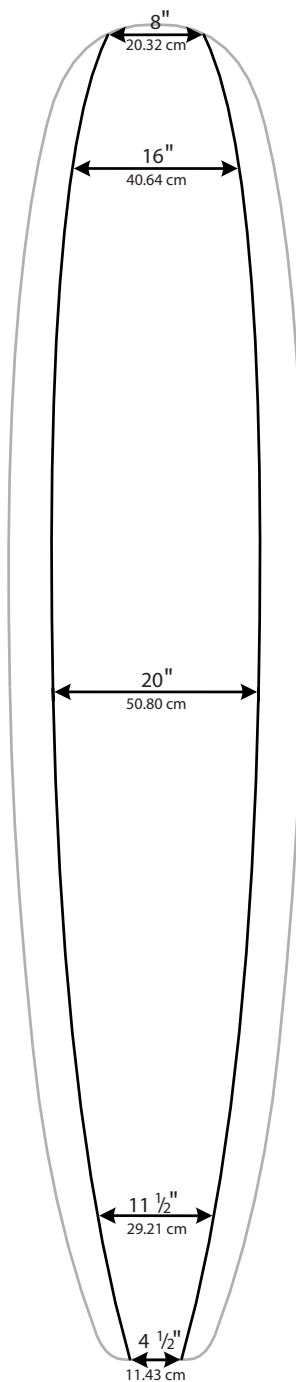

Overall Template Length: 9' 4" (284.48 cm)

Blank Width: 24 11/16" (62.71 cm)
(1/2" narrower than standard 9'4B)

Notes: This template is suitable for long board shapes 9'4" and under.

This outline can be used on the following blanks:

93Y, 94B, 95M, 98Y and 98EPS

* * All parabolic dimensions are "inside widths" measured across from cut to cut. Extra width must be added to the dimensions listed to account for thickness of stringers. Overall blank width is narrower due to the thickness of material removed during the cutting process.

Available Rockers:

94B Natural Rocker



MULTI BOARD BOXES WITH BOX ENDS

BOX SIZE:	INSIDE DIMENSIONS		
	LENGTH	WIDTH	HEIGHT
1. 7'4"	7'2" (2.24 m)	25" (63.5 cm)	12" (30.5 cm)
2. 8'4"	8'2" (2.49 m)	25" (63.5 cm)	12" (30.5 cm)
3. 10'8"	10'6" (3.32 m)	26" (76.2 cm)	14" (35.5 cm)
4. 12'5"	12'3" (3.73 m)	33" (83.8 cm)	12.5" (31.6 cm)

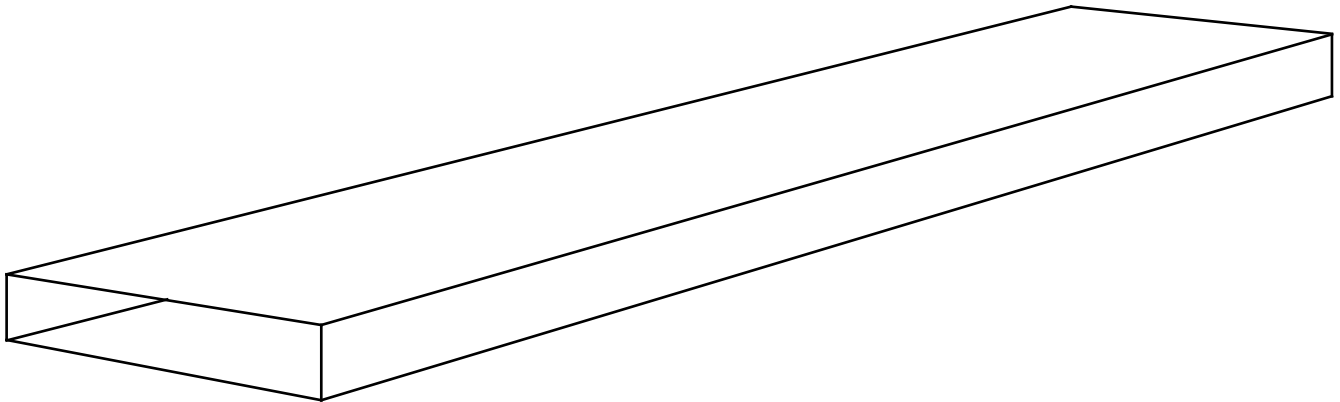

BOXES ARE A GLUED TUBE MADE OF 275# KRAFT

ENDS STAPLE IN FOR A STRUCTUAL FIT.

BOXES ARE PLAIN WITH NO LOGO.